

EcoFlow STREAM Ultra/Pro

Thank you for choosing our product!

Contents

About This Manual

Overview

Appearance

Control Button

LED Indicator

Device Expanding Capability

Get Started

Understand the EcoFlow STREAM Series Plug & Play Solar Plant

Set Up Essential Power Connections

Supply Power to Appliances

Smart Control

EcoFlow App

Register and Log In

Bind the Device and Set Up the Internet

Access Device Management

Explore More

Increase Available Power Source

System Expansion

System Scheduling

Storage and Maintenance

Routine Maintenance

User-Replaceable Parts Maintenance

Long-term Storage

Troubleshooting

Safety Instructions and Regulatory Compliance

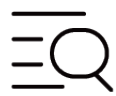

FAQ



EcoFlow App



After-sales
Policy



Community

About This Manual

- **Applicable Product Model:** EcoFlow STREAM Ultra, EcoFlow STREAM Pro
- This manual contains an introduction to this product, and details on its operation, management, and maintenance. Please note that this manual may be updated without prior notice.
- The availability of certain accessories and features described in this manual may vary depending on your country or region.
- All images displayed in this manual are for demonstrative purposes only. Please refer to the actual product received. **EcoFlow STREAM Ultra** will be used as the example product in this manual.
- If you are reading this manual in PDF format, please note that you can access it online at <https://www.ecoflow.com/support/download/index> for a better experience and the latest updates.

Overview

EcoFlow STREAM Ultra / EcoFlow STREAM Pro (hereinafter referred to as "the device") is a solar storage system designed for both new installations and retrofits of existing solar power systems. The device features terminals for solar input, grid connection, parallel connection, and two standard AC outlets. Internally, it integrates an inverter, MPPT charge controller, and battery modules to enable efficient energy storage and management.

Appearance

Disclaimer

Safety Symbols

Safety Instructions

Regulatory Compliance

Appendix

What's in the Box

Technical Specification

Product Compatibility List



1	Recess Handle	Used for safely lifting and moving the device.
2	Protective Cover	Used for shielding electrical terminals and outlets from dust, moisture, and accidental contact.
3	Grounding Terminal	Used for providing a supplemental ground connection.



4	DIY Front Case	Used for maintaining the original appearance. DIY replacement cases are available for purchase.
5	Power Button	Used for turning the device on or off and resetting IoT settings.
6	System Status LED	Used for indicating the current operating status of the device.

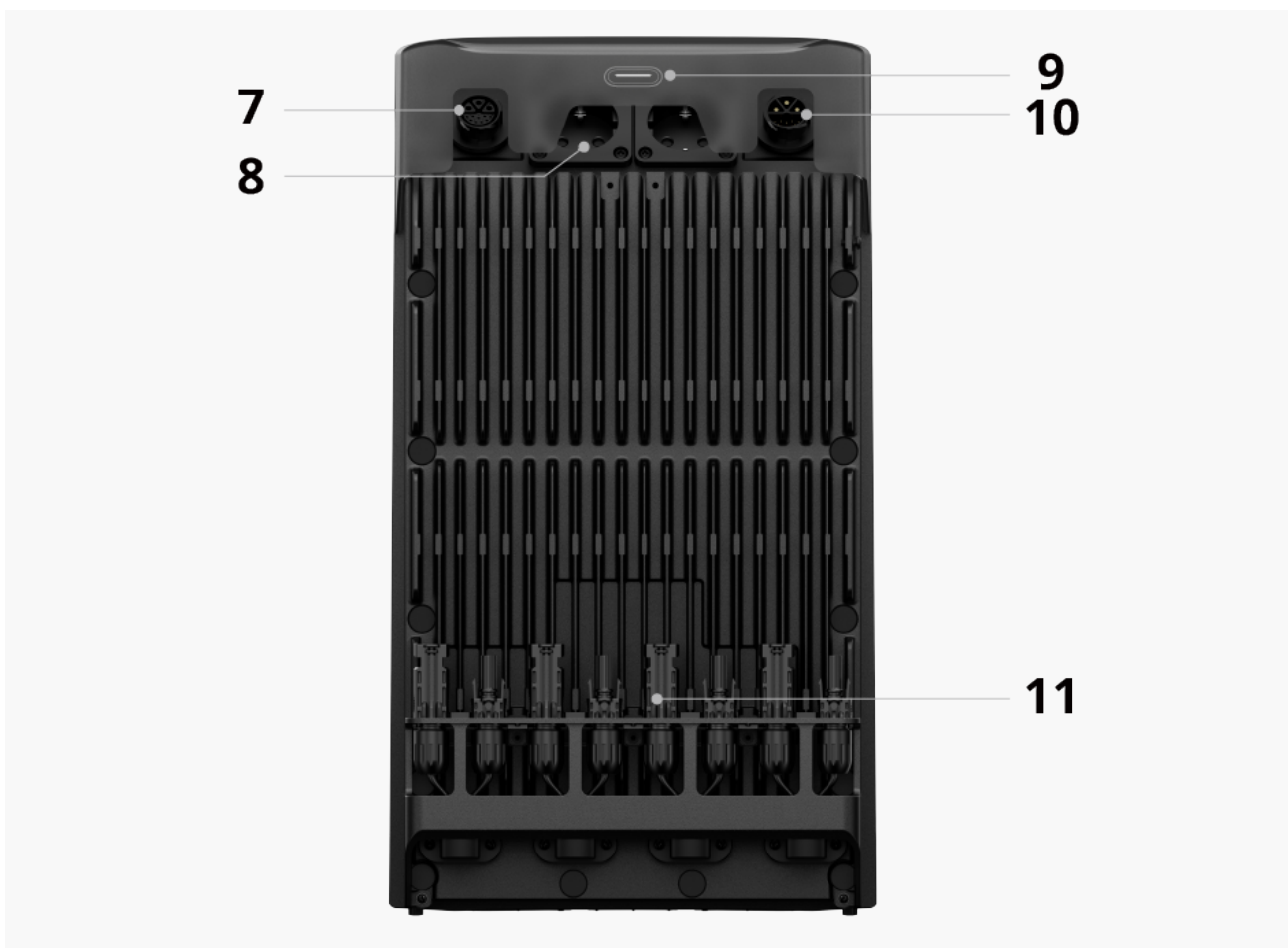

7	Parallel Terminal	Used for connecting multiple units to enable system expansion, inter-unit communication, and increased output power of the AC outlets.
8	AC Outlets †	Used for supplying power to connected appliances or connecting to a microinverter to add extra power input.
9	AC ON/OFF Button	Used for enabling or disabling the AC outlets.
10	Grid Terminal	Used for connecting the device to the utility grid or for paralleling with another unit.
11	PV Terminals ‡	Used for connecting solar panels for power input.

 † The actual appearance of the AC outlet may vary by sales region and product version.
 ‡ The STREAM Ultra has 4 pairs of PV terminals, while the STREAM Pro has 3 pairs.

Control Button

Power Button

The button serves the following functions:

- **Power On:** Press and hold the button for 2 seconds to turn on the device.
- **Power Off:** Press and hold the button for 2 seconds to turn off the device. If solar or grid power is present, disconnect the cables before powering off.
- **Reset IoT:** Press the button 5 times in quick succession to reset Wi-Fi and Bluetooth connections.



Resetting the IoT settings will unbind the device from your EcoFlow account.

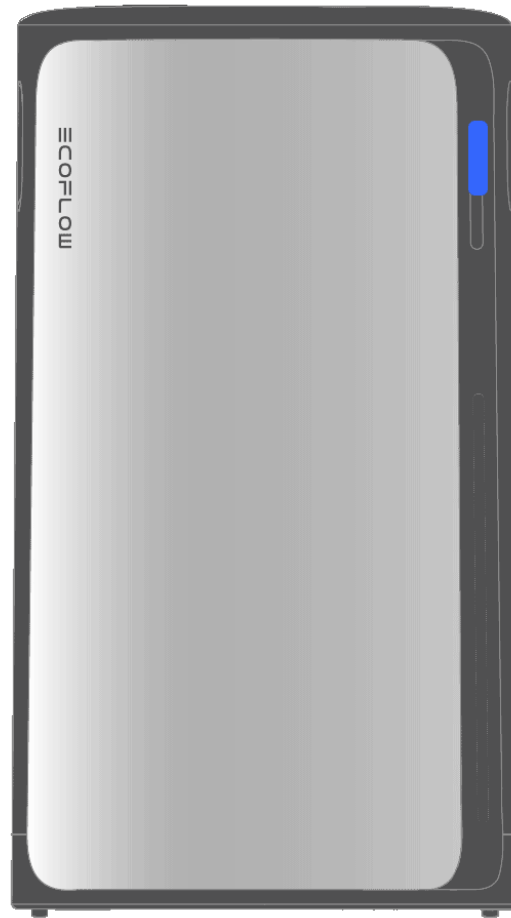

AC ON/OFF Button

The button serves the following function:

- **AC On:** When the outlets are disabled, press once to enable the AC outlets.
- **AC Off:** When the outlets are enabled, press once to disable the AC outlets.

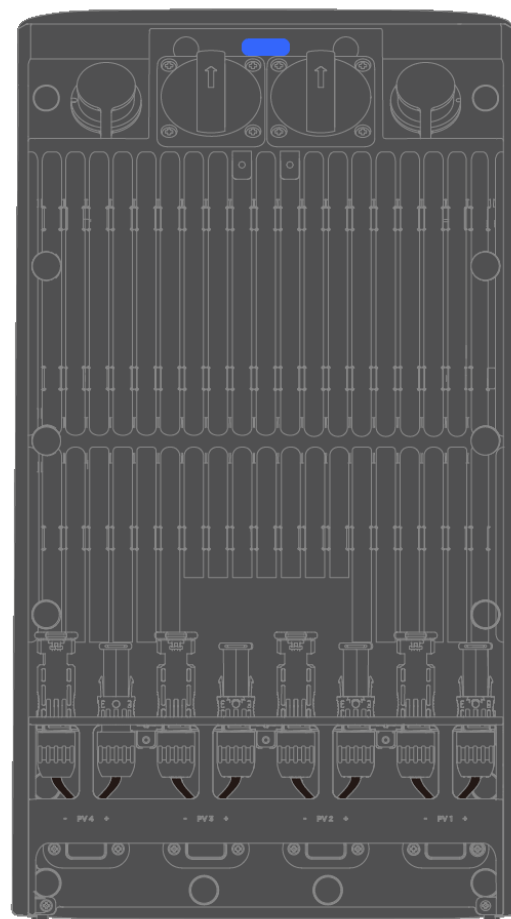

LED Indicator

System Status LED

The following LED pattern indicates that the device is powered off.



The following LED pattern indicates the current battery level of the device.



The following LED pattern indicates that the device is being charged.

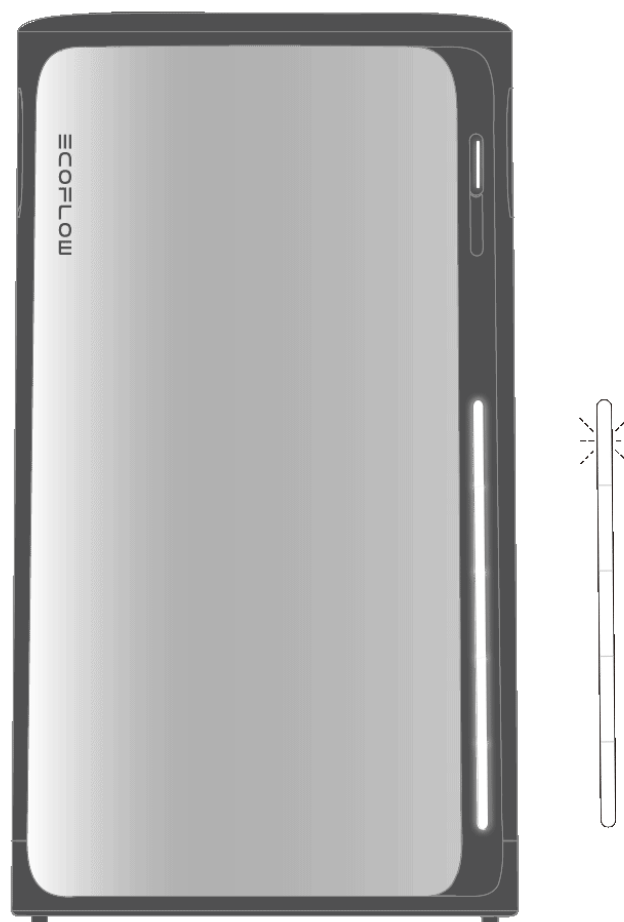

The following LED pattern indicates that the device is faulty. Check the EcoFlow app for further instructions.



The following LED pattern indicates that a setting has been applied, such as a system reset or the completion of internet setup.

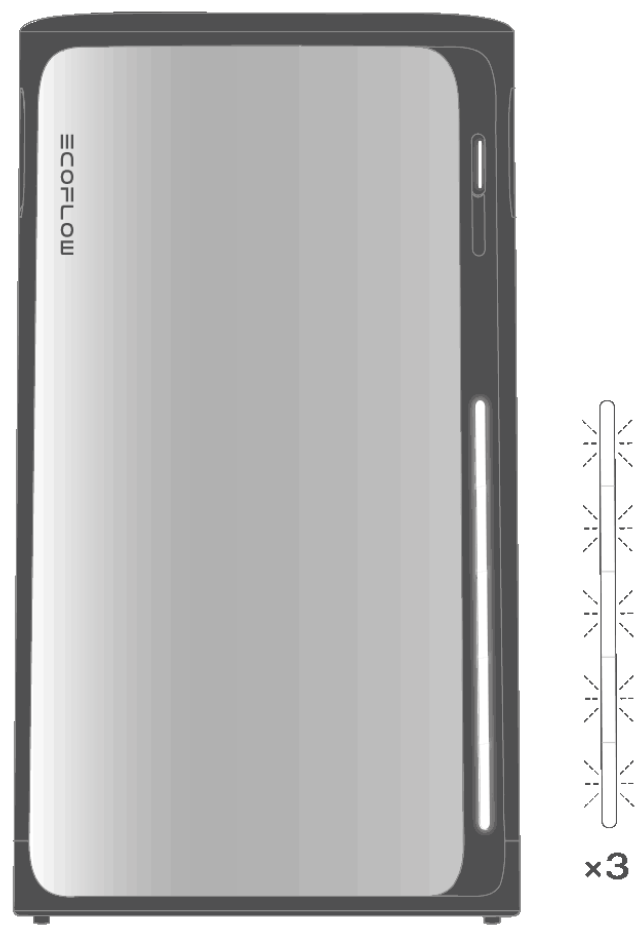

The following LED pattern indicates that the device is upgrading its firmware.



AC Outlet Status LED

The following LED pattern indicates that at least 1 AC outlet is enabled.

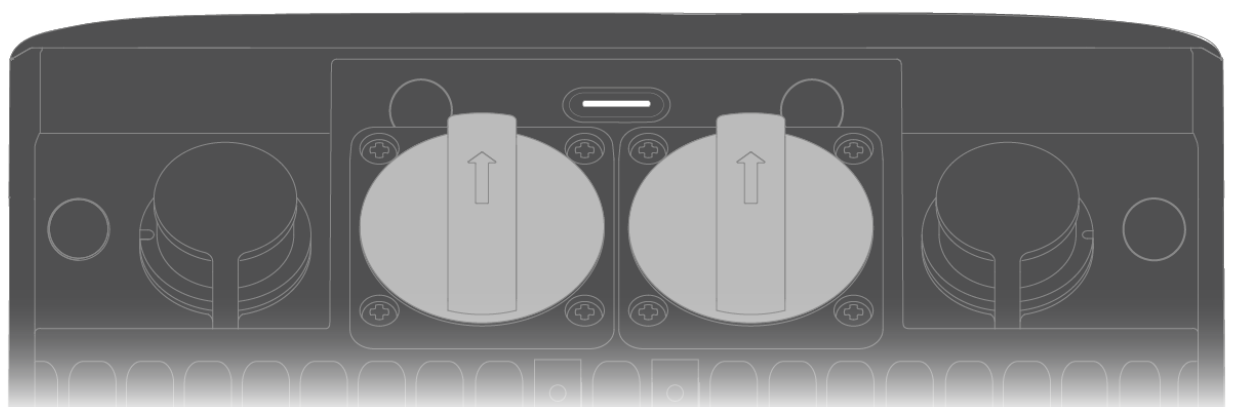

The following LED pattern indicates that AC outlets are disabled.

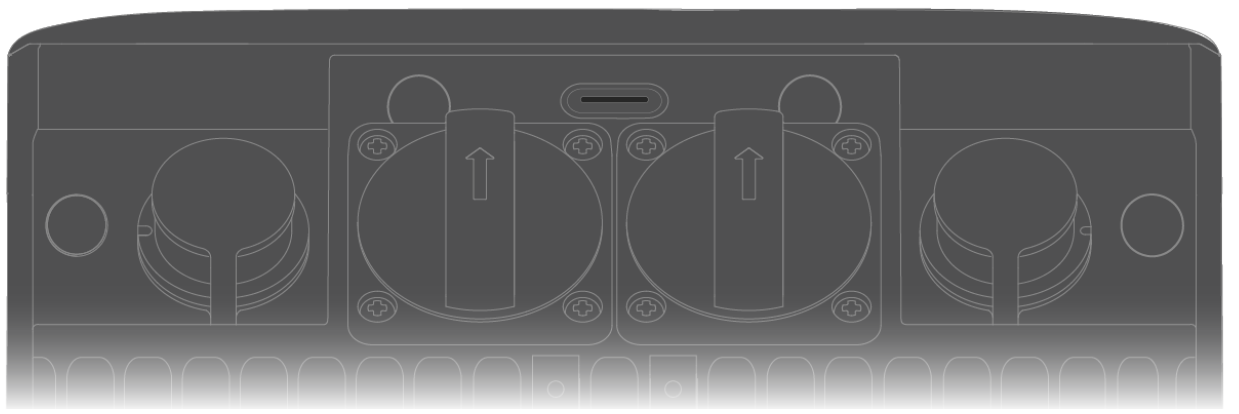

Device Expanding Capability

EcoFlow STREAM devices support system expansion to increase total battery capacity and enable power scheduling, unified app-based management, and flexible installation to fit various spaces. Multiple STREAM Series devices can be installed based on your specific needs.

Option 1

Connect at least 2 STREAM devices in a daisy-chain configuration to expand the total battery capacity. All devices are installed in the same location. While some devices support their own solar input, this setup is ideal when all connected solar panels face the same direction. The system can support a maximum scheduling capacity of 2300W for connected appliances.

Option 2

Use at least 1 STREAM device per location, distributed across different rooms or areas—ideal if you have multiple solar power sources facing different directions around your house. In this setup, each device operates independently, and its scheduling capacity is limited by the grid-feed power permitted by local regulations.

Maximum Number of Devices

You can connect or install up to 6 STREAM devices in your home.

Compatible STREAM Devices

- EcoFlow STREAM Ultra
- EcoFlow STREAM Pro
- EcoFlow STREAM AC Pro
- EcoFlow STREAM AC
- EcoFlow STREAM Max



The compatibility list reflects supported models at the time of publication. For the most up-to-date information, visit the official product website at <https://www.ecoflow.com>.

Network Requirement

To ensure proper communication and synchronization, all STREAM devices must be connected to the same Wi-Fi network.

Stacking and Placement

STREAM devices can be stacked to save space. In this case, make sure the provided securing brackets are properly installed to prevent accidental tipping or falling. Avoid stacking more than two layers.

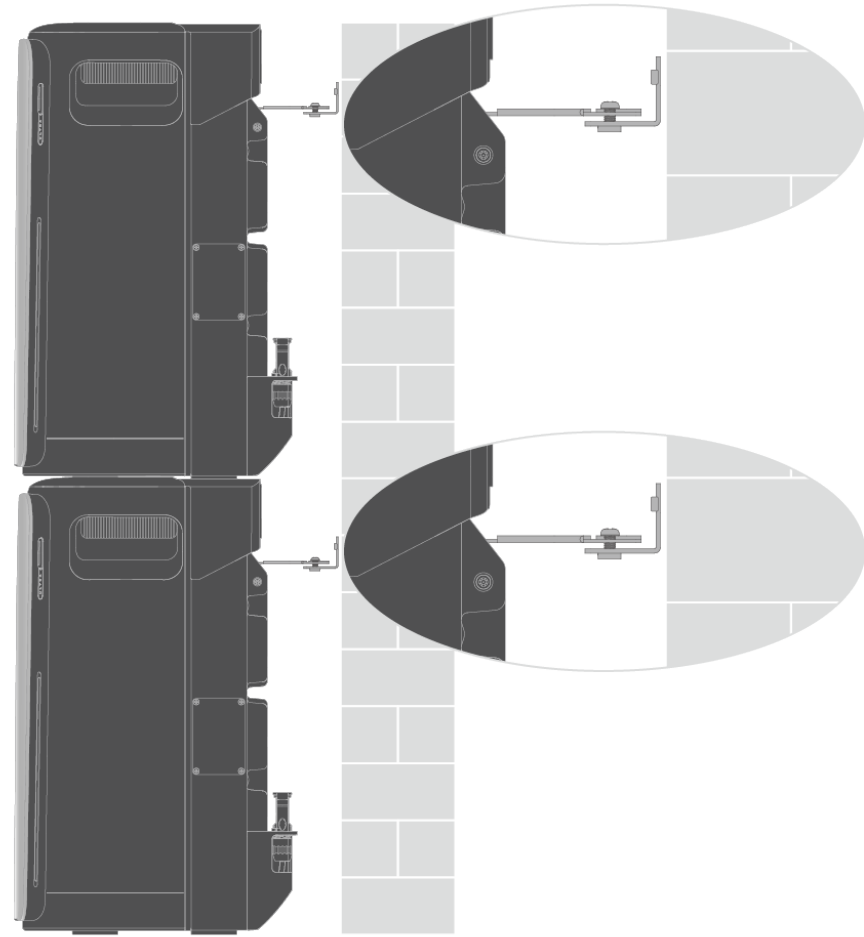

For detailed mounting instructions, refer to the Installation Guide provided in the product package or available at <http://www.ecoflow.com/support/download/>.

Get Started

Understand the EcoFlow STREAM Series Plug & Play Solar Plant

The EcoFlow STREAM Series Plug & Play Solar Plant is a residential energy system designed for straightforward integration with home circuits. It stores surplus solar energy and discharges it during periods of high electricity demand or grid outages, helping to reduce utility costs and enhance energy reliability.

To understand how the system works, let's briefly review its main parts:

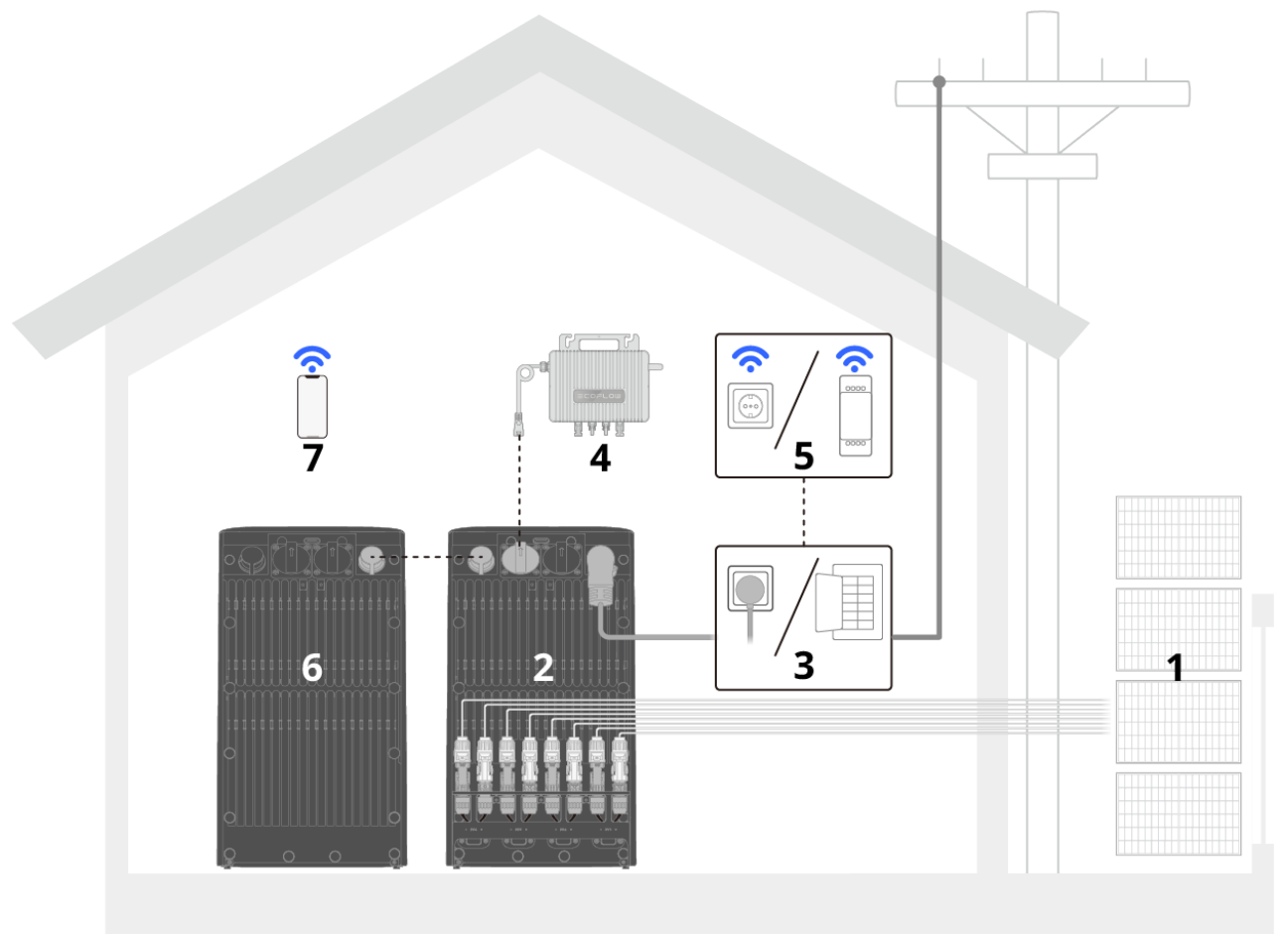

1 Solar panels Absorbs sunlight and generates direct current (DC) electricity.
Tip: Use EcoFlow solar panels or compatible third-party panels that meet the device's DC input requirements.

EcoFlow STREAM Ultra / EcoFlow STREAM Pro Feeds power from solar panels into the grid, powers appliances via an outlet or the home's electrical system, and stores excess energy.

3 Specified cables Connects the device to external power sources, electrical devices, and other equipment for proper system integration and operation.

- **For grid connection:** EcoFlow STREAM AC Cable / EcoFlow STREAM DIY Cable
- **For solar connection:** EcoFlow STREAM Solar Panel Extension Cable
- **For parallel connection (optional):** EcoFlow STREAM Parallel Cable

Optional: 4 Extra Microinverter Provides additional power input to feed the grid, charge the battery, or supply connected appliances in bypass mode.

Optional: 5 Smart Sensor Adjusts the reference data used in the system's scheduling scheme. The device features a basic scheduling logic, which can be further optimized by adding smart sensors. You can choose one of the following accessories:

1. **Smart Plug (for partial scheduling):** Tracks and measures the energy consumption of connected appliances to optimize their energy usage.
2. **Smart Meter (for whole-home scheduling):** Monitors the energy consumption and generation of the entire household to optimize the energy distribution.

Tip: For compatible plug or meter models, always refer to the latest compatibility information at the official product site: www.ecoflow.com.

- Optional:
- 6 Extra STREAM devices Expand the overall system by increasing total battery capacity and offering more flexible installation options.
 - 7 EcoFlow App Enables control and monitoring of the system via your phone.



Electrical codes may vary by region. Before setting up a Plug & Play Solar Plant, check your local regulations and consult a qualified electrician to ensure everything is done safely and in compliance with the applicable laws.

Set Up Essential Power Connections

Environment Requirement

Ensure that the installation site meets the necessary conditions for proper device operation:

1. The device should be installed in a dry, clean, and well-ventilated area.
2. Do not expose the device to direct sunlight, snow, or rain.
3. Avoid installing the device near water, heat sources, or flammable/explosive materials.

Solar Connection

Connect the solar panels to the device to ensure proper solar power input. Make sure the solar panels meet the specifications of the device's PV terminals.

1. Connect the provided solar cables to the PV terminals on the device.
2. Connect the other ends of the cables to the connectors on the solar panels.

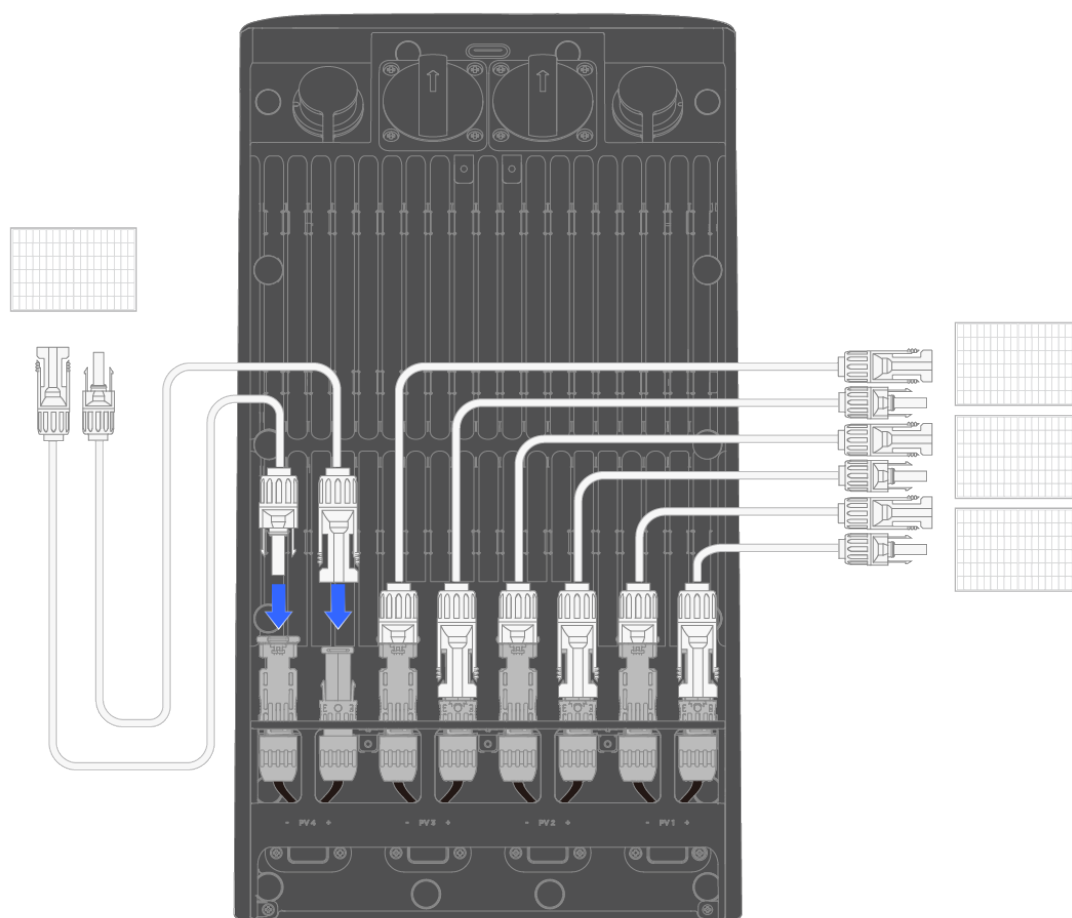



When connecting solar panels, ensure that a single panel's positive and negative leads are connected to the same PV terminal pair (e.g., PV1+ and PV1-). Do not connect the leads across different terminal pairs (e.g., positive to PV2+ and negative to PV1-), as this may cause a short circuit.



1. **Recommended Cable:** EcoFlow STREAM Solar Panel Extension Cable
2. If you need to adjust the solar connection, use the provided PV wrench to detach the connector.
3. Keep unused PV terminals covered with their protective caps.
4. The device will power on automatically once connected to an active power source.

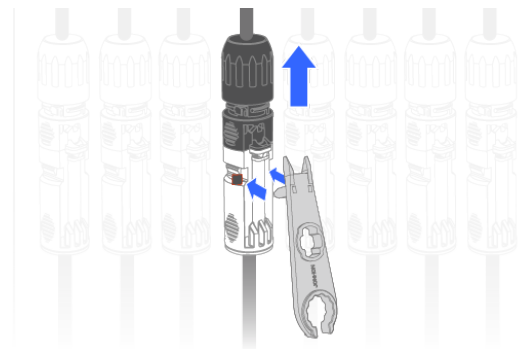

Grid Connection

Connect the device to the grid to enable it to feed power into the grid or draw power from it when solar energy is insufficient. This can be done via a standard home outlet (if permitted), or through a circuit breaker (in regions like the United Kingdom).

- **Direct Plug-in Connection**

For installation sites where direct plug-in to a home outlet is permitted by local regulations:

1. Connect the provided AC cable to the Grid terminal on the device.
2. Tighten the screw on the cable plug to secure the connection.
3. Plug the other end of the cable into a standard home outlet.

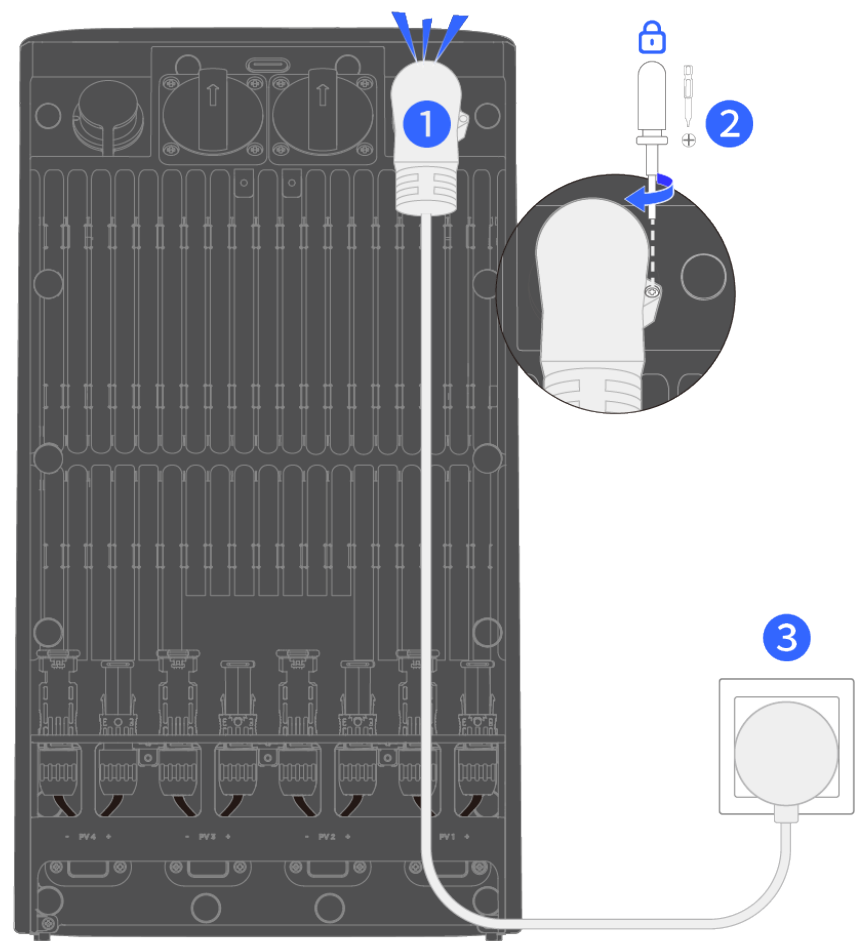

1. **Recommended Cable:** EcoFlow STREAM AC Cable
2. The device will power on automatically once connected to an active power source.
3. If the device is used outdoors, connect it to an IP68-rated weatherproof outlet.

- **DIY Connection (Optional)**

A qualified electrician is required to connect the device to a home circuit breaker.

1. Power off the home circuit at the installation site.
2. Connect the provided DIY AC cable to the Grid terminal on the device.
3. Tighten the screw on the cable plug to secure the connection.
4. Connect the other end of the DIY cable to a circuit breaker in the distribution box:
 - Connect the PE (ground) wire to the PE bar.
 - Connect the N (neutral) wire to the neutral bar.
 - Connect the L (live) wire to the breaker terminal that leads to the load side.

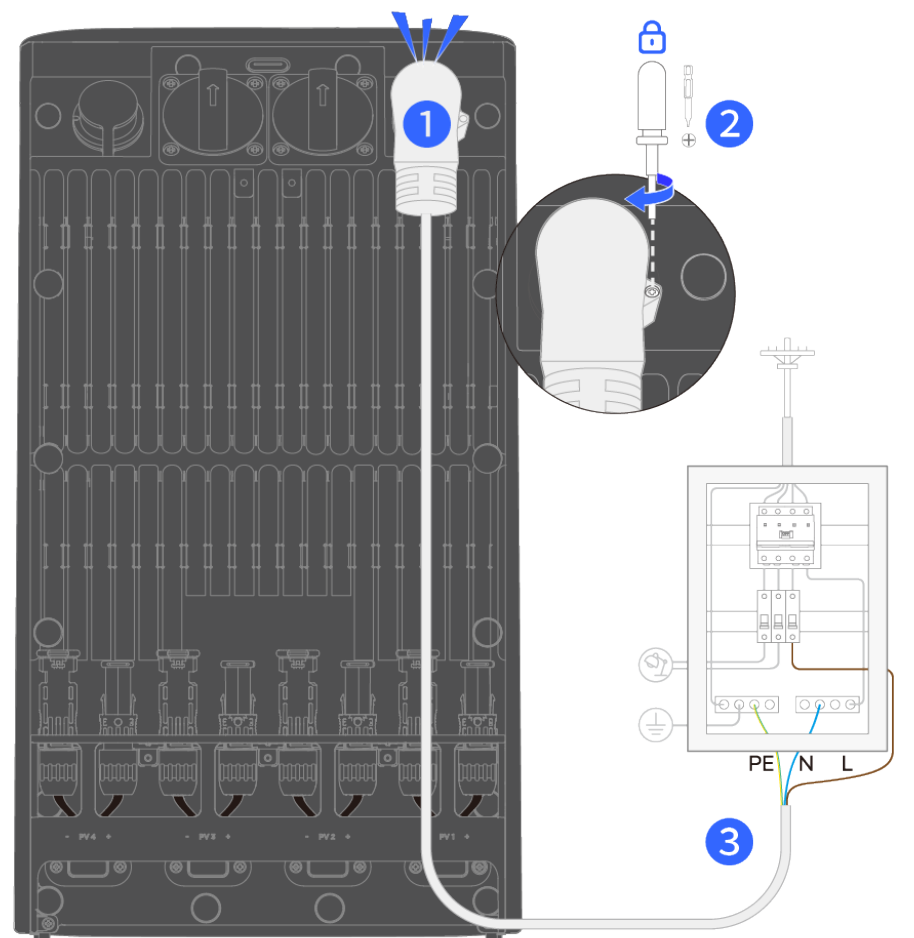

1. **Recommended Cable:** EcoFlow STREAM DIY Cable
2. The device will power on automatically once connected to an active power source.
3. The illustration is for reference only. Installation must be performed according to actual site conditions and applicable regulations.

Grounding Considerations

Proper grounding is essential for safe operation. EcoFlow offers an AC cable with an equipment grounding conductor/a grounding plug. If the cable has been plugged into an outlet that is properly installed and grounded in accordance with all local codes and ordinances, the device will be properly grounded. However, if you encounter the following situations, consult a qualified electrician:

- You are unsure whether the product is properly grounded;
- You find that the plug provided with the product does not fit the outlet.

If the installation site does not meet grounding requirements or specific grounding standards mandated by local codes, ask a qualified electrician to use the grounding terminal on this product to establish proper grounding.



Grounding work shall be performed only by a qualified electrician.

Supply Power to Appliances

The device supports supplying power to appliances through the AC outlet on the device or via an existing home circuit, allowing flexible connection of appliances.

Application 1: Appliances Connected to the Device's AC Outlets

Connect the appliance directly to the device's AC outlet.

The power supply may come from solar energy, grid power, or the device's battery storage. When at least two devices are connected in parallel, the additional units further enhance the power supply, enabling the system to deliver up to 2300W to connected appliances.

In this application, the device also provides backup power by automatically switching to battery power during a grid outage to keep the connected appliances running.

- **To Connect an Appliance**

1. Plug your appliance into the AC outlet on the device.
2. Press the AC ON/OFF button once to enable the AC outlet.

- **To Remove an Appliance**

1. Power off the connected appliance and disconnect it.
2. Press the AC ON/OFF button once to disable the AC outlet.

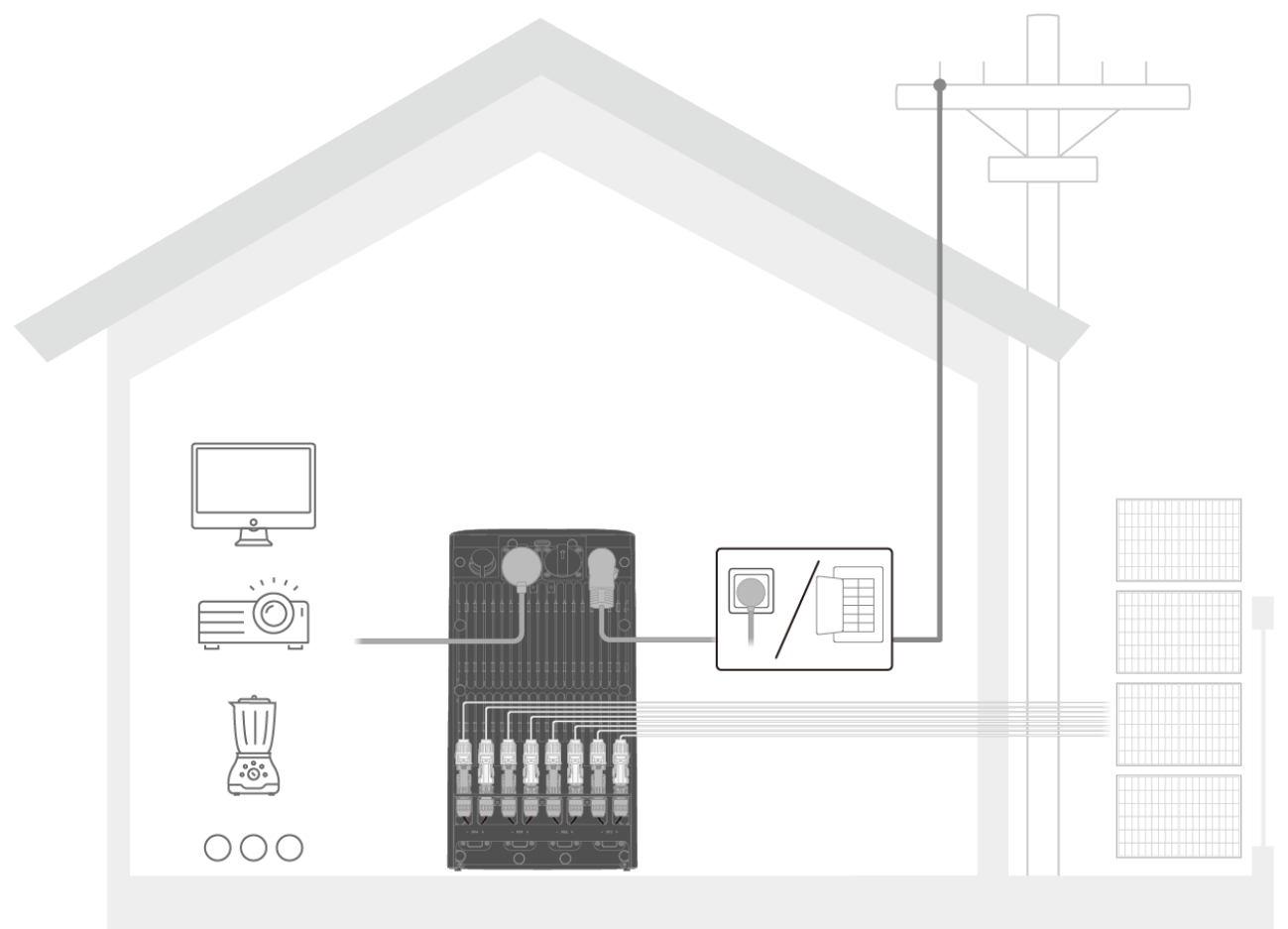

i The backup power switch time varies depending on solar power efficiency and battery conditions, and may take up to 3 seconds. Do not connect appliances that require seamless power switching, as this device is not designed to function as an uninterruptible power supply (UPS).



The AC outlet remains enabled when grid power is connected. When off-grid and the outlet is not in use for approximately 2 hours, it automatically disables. After 30 minutes of inactivity, the device will automatically shut down to save battery.

Application 2: Appliances Connected to Other Home Outlets

Connect the appliance directly to another wall outlet in your home. When the device is connected to the home circuit (e.g., through an outlet or circuit breaker), it automatically manages power distribution based on the settings in the EcoFlow app. Once another home outlet draws power for an appliance, the device supplies the corresponding output. The maximum power the device (and its cascaded system, if applicable) can support is limited by the available grid-feed power.

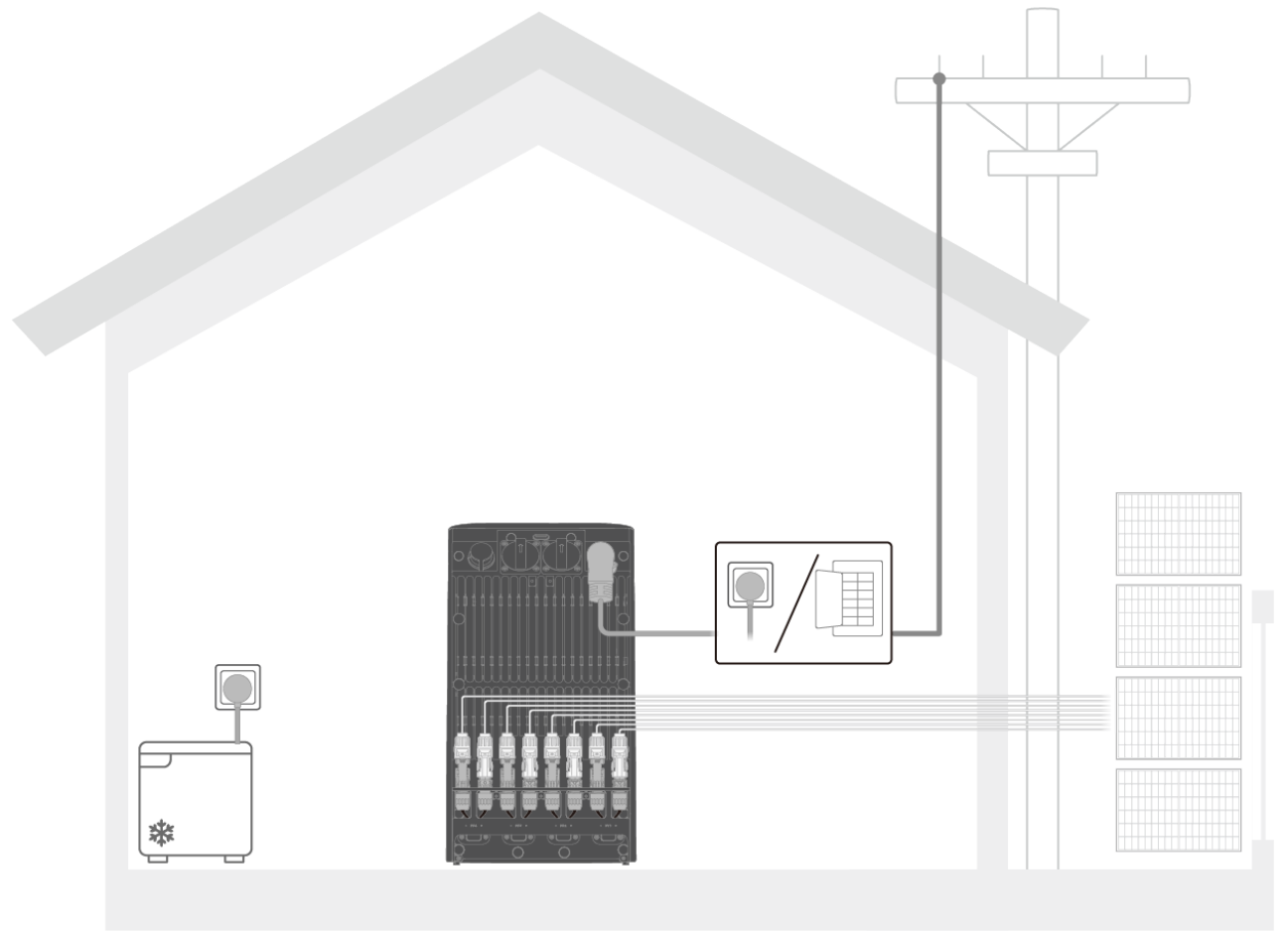

In this mode, if there is a grid power outage, the device will not automatically switch to battery power to supply the load. You can manually connect appliances to the device's AC outlets.

Smart Control

EcoFlow App

App Introduction

EcoFlow offers a companion app for device management. With this mobile application, you can:

- Enjoy all-in-one control of your EcoFlow devices from anywhere.
- Monitor power consumption details seamlessly with real-time updates.
- Personalize your energy scheme with an array of customizable options.
- Promptly receive in-app troubleshooting and firmware updates.

App Download Methods

1. Scan the QR code to download.
2. Search for "**EcoFlow**" in the iOS or Android app store.
3. Visit <https://download.ecoflow.com/app> to download.



<https://download.ecoflow.com/app>



The EcoFlow app continuously adapts to enhance the user experience and functionality. Screenshots in this manual are for demonstration purposes only. The actual appearance may vary depending on the app version and operating system. This manual does not cover every detail of the app's functions, and users are encouraged to explore the app themselves.

Register and Log In

- **To Register an Account**

1. Open the EcoFlow app and tap "**Create new account**".
2. Enter the required registration information, then tap "**Sign up**". The email address you entered will be used as your EcoFlow account.

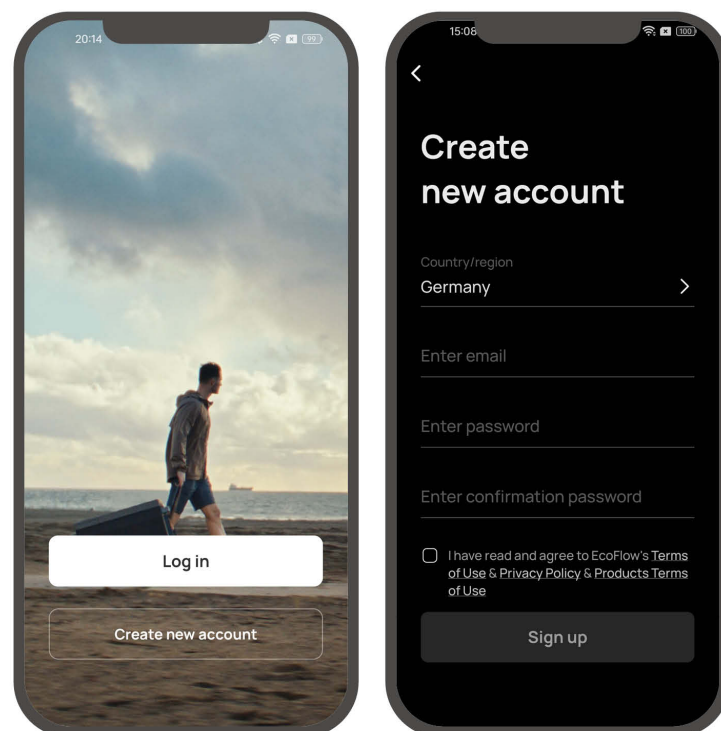

- **To Log In**

1. Open the EcoFlow app and tap "**Log in**".
2. Enter your registered email address and password, and proceed to access the device management page.

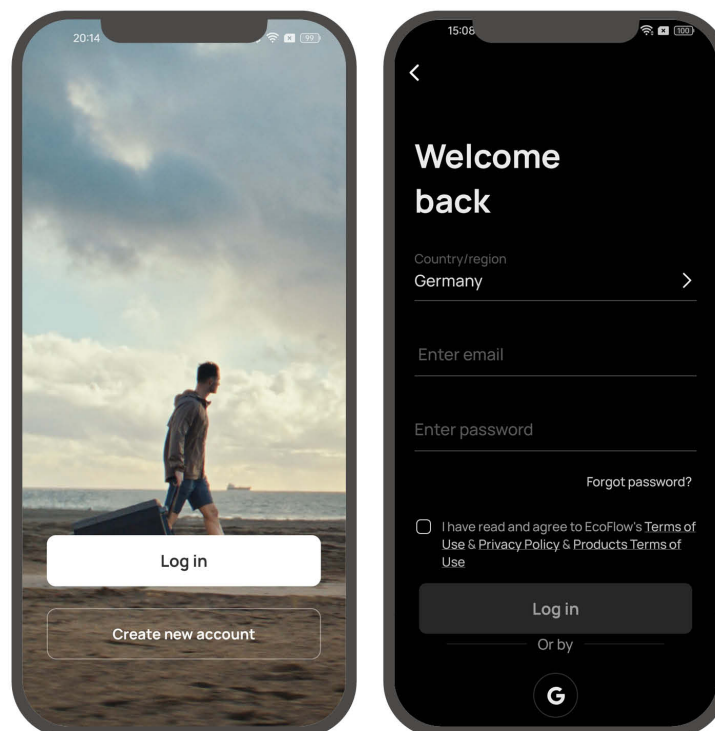

Bind the Device and Set Up the Internet

When you first set up a new device, bind it to your EcoFlow account to ensure remote access to the device's settings.

- **To Bind a New EcoFlow Device/System:**

1. Visit the EcoFlow app and log into your EcoFlow account.
2. Tap the "Add Device" button or "+" icon in the top right corner to search for new EcoFlow devices.
3. Select your EcoFlow device and follow the pop-up instructions to complete device binding and Wi-Fi setup.

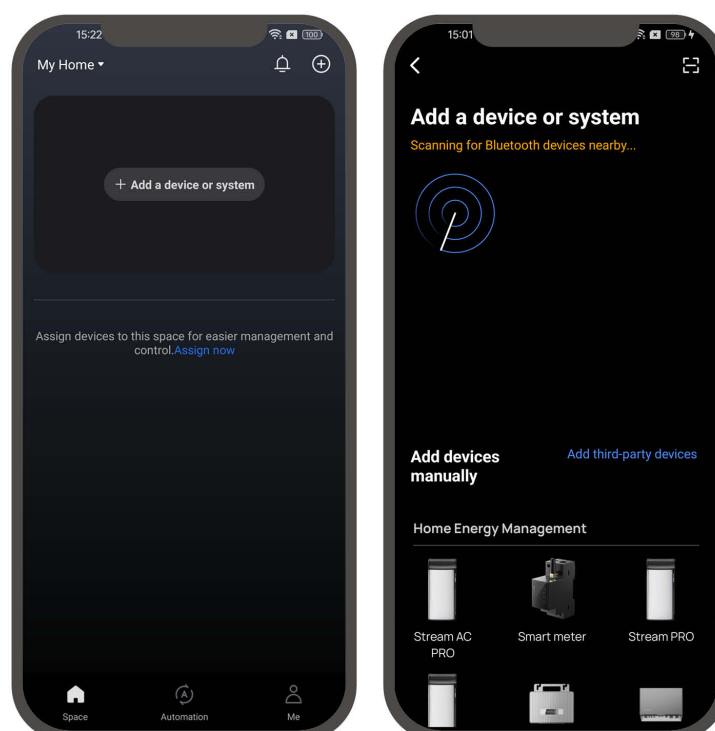

Access Device Management

With the EcoFlow app, you can manage all your bound devices via phone. The product supports Wi-Fi and Bluetooth connections, adapting to different network conditions to ensure convenient access to device settings.

- **With Internet**

When Wi-Fi is stable, you can access the device settings via the internet. This method is always recommended to ensure your EcoFlow device can receive timely firmware updates and pushes.



- **Without Internet**

If the Wi-Fi connection is unavailable, you can manage the device locally via Bluetooth, though some settings may be restricted.



i For local control, you can only view the management page of each unit separately. Full system control requires internet access.

Explore More

Increase Available Power Source

The device's AC outlets support bidirectional power flow for both charging and discharging. Adding an extra microinverter increases input capacity and improves overall charging efficiency.

- **To Connect a Microinverter**

1. **Prerequisite:** Ensure your microinverter supports direct plug-in with a standard AC outlet and complies with local regulations. EcoFlow microinverters are preferred; third-party models may require additional measures.
2. After connecting the microinverter to solar panels, plug its AC output cable directly into the device's AC outlet.
3. Press the AC ON/OFF button on the device once to enable the outlet.

- **To Disconnect a Microinverter**

1. Press the AC ON/OFF button on the device once to disable the outlet.
2. Unplug the microinverter's AC connection cable from the device's AC outlet.

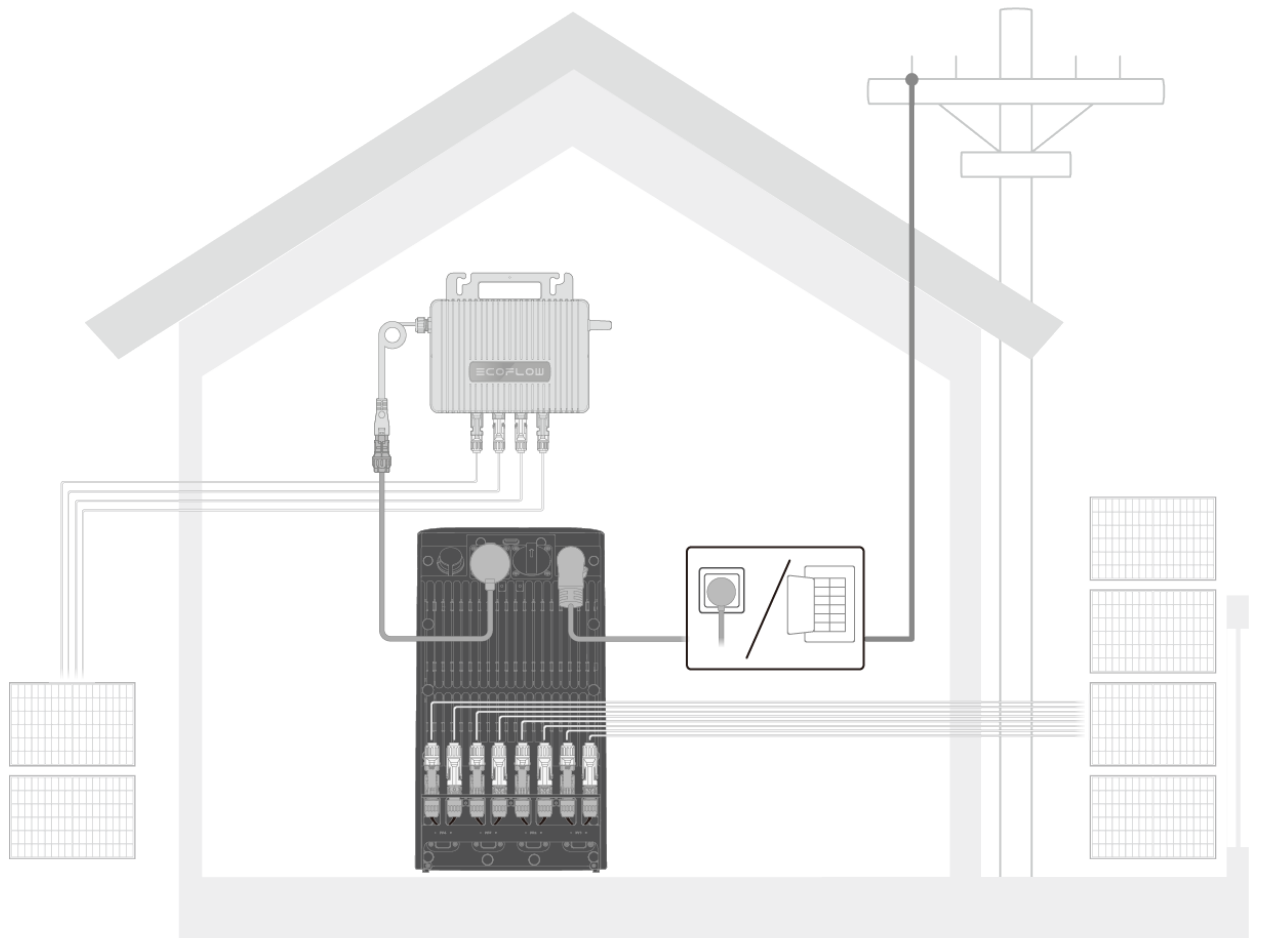

EcoFlow recommends integrating only ONE microinverter with your STREAM system.

System Expansion

Method 1: Single-Room Cascaded Configuration

This configuration connects multiple STREAM devices in a single room to expand system capacity using a daisy-chain layout. Devices are linked via parallel cables and share a common grid input. The device directly connected to the grid functions as the main device, while the others operate as sub-devices within the cascade, participating in power delivery and control.

- **To Parallel a Cascaded System**

1. Ensure all STREAM devices are powered off. If there are any connections to the grid or solar, disconnect the cables and then press the power button for 2 seconds to turn the device off.
2. Plug the **EcoFlow STREAM Parallel Cable** into the Parallel Terminal and Grid Terminal between STREAM devices, and tighten the screws on both ends. If you have multiple devices, repeat this step until there is one Grid terminal (usually on the first unit) and one Parallel terminal (usually on the last unit) left unused in this connection chain.
3. Connect the **EcoFlow STREAM AC Cable** to the first STREAM device's Grid Terminal and the grid, and tighten the screw on the plug. This device will be considered the main device, while the others will be sub-devices.
Tip: Once connected to an active power source, STREAM devices will power on automatically.
4. Open the EcoFlow app to bind the STREAM devices to your account. Make sure all devices are connected to the same Wi-Fi network.

- **To Remove a Cascaded System**

1. Power off the connected appliances and disconnect them.
2. Disconnect the main device from the grid and disconnect all devices from

any solar input. If either the grid or solar connection is present, powering off the devices will not take effect.

3. Press the power button for 2 seconds to turn off each device.
4. Unfasten the screws on both ends of the parallel cable to release the plugs. Then, rotate the plug counterclockwise and remove the cable.
5. Open the EcoFlow app and unbind the devices from your account if necessary.

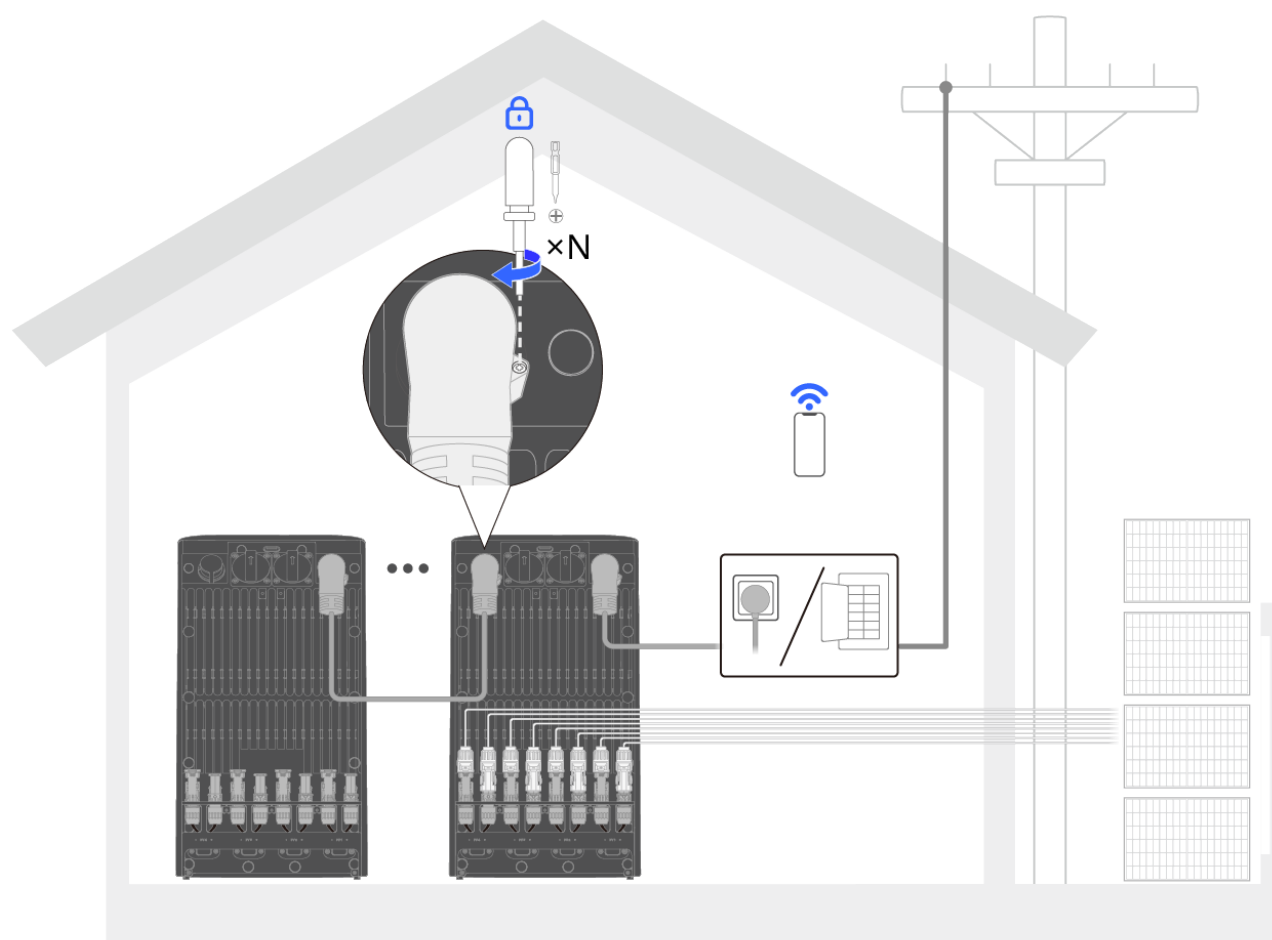

- i** 1. The parallel connection should only be performed when the main device is disconnected from the Grid.
- 2. If the grid connection fails, the paralleled units cannot function as a system and will operate separately.

- 💡** 1. The default protective cap should be kept on any unused terminal.
- 2. Up to 6 STREAM devices can be installed in a system. Cascaded and distributed configurations can be combined freely within this limit.

Method 2: Multi-Room Distributed Configuration

- ⚠️** This setup is only allowed if local electrical regulations permit the device to be plugged directly into a home socket.

This configuration allows STREAM devices to be installed in different rooms, offering flexible placement throughout the home. Each device connects individually to an AC socket on the same power circuit, while still sharing battery resources across the system. Synchronized power management and communication are enabled through the existing home circuit and WLAN, eliminating the need for physical parallel cabling.

- **To Install a Distributed System**

1. Connect the EcoFlow STREAM AC Cable to a STREAM device's Grid Terminal to a home outlet and then tighten the screw on the plug. Tip: Once connected to an active power source, STREAM devices will power on automatically.
 2. Connect additional STREAM devices separately in the rooms where you want to assign them.
 3. Open the EcoFlow app to bind the STREAM devices to your account. Make sure all devices are connected to the same Wi-Fi network.
- **To Remove a Distributed System**
 1. Power off the connected appliances and disconnect them.
 2. Disconnect all STREAM devices from the grid and any solar input. If either is connected, powering off the devices will not take effect.
 3. Press the power button for 2 seconds to turn off each device.
 4. Move or store the devices as needed.
 5. Open the EcoFlow app and unbind the devices from your account if necessary.

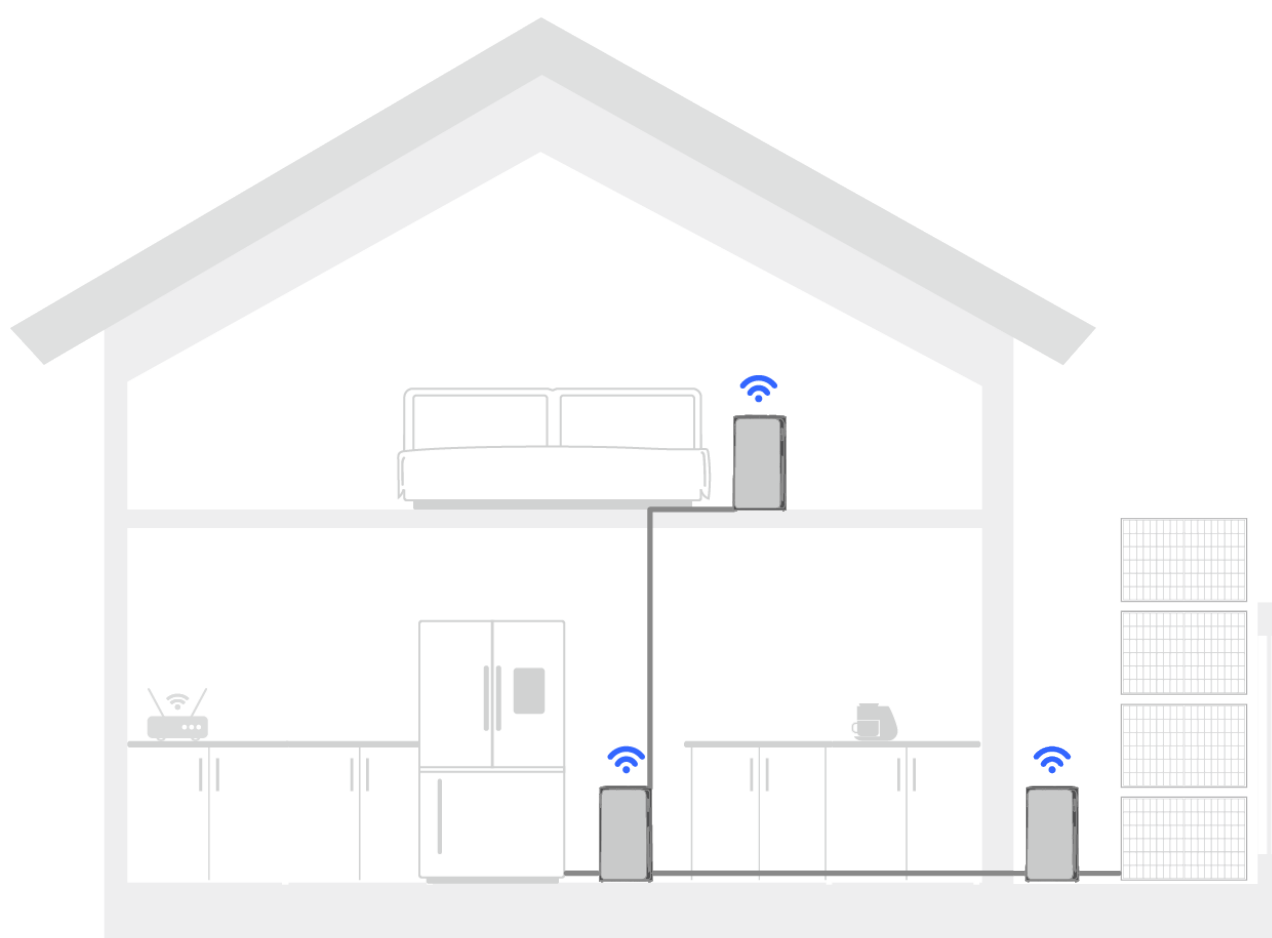

1. The default protective cap should be kept on any unused terminal.
2. Up to 6 STREAM devices can be installed in a system. Cascaded and distributed configurations can be combined freely within this limit.

System Scheduling

The STREAM device supports a basic power scheduling scheme. When no smart sensor is integrated, the feed-in power cannot be adjusted in real-time according to household power consumption. Instead, it can only be manually set to a fixed power, or scheduled based on specific periods via the EcoFlow app. Smart sensor integration enhances scheduling capabilities.

Flexible Scheduling with Smart Plug

A smart plug allows you to manage when appliances are powered on or off through the EcoFlow app, offering more flexibility in physical placement. Once integrated into the system, STREAM devices will adjust feed-in power based on the total load of appliances connected to the smart plug, prioritizing their power supply and backup resources.

- **To Add a Smart Plug**

Follow the Smart Plug's user manual to complete the installation. Ensure the plug is connected to the same wireless network as the STREAM system.

- **To Remove a Smart Plug**

1. Power off the connected appliances, then remove the plug from a home outlet.
2. Move or store the smart plug as needed.
3. Open the EcoFlow app and unbind the smart plug from the STREAM system if necessary.

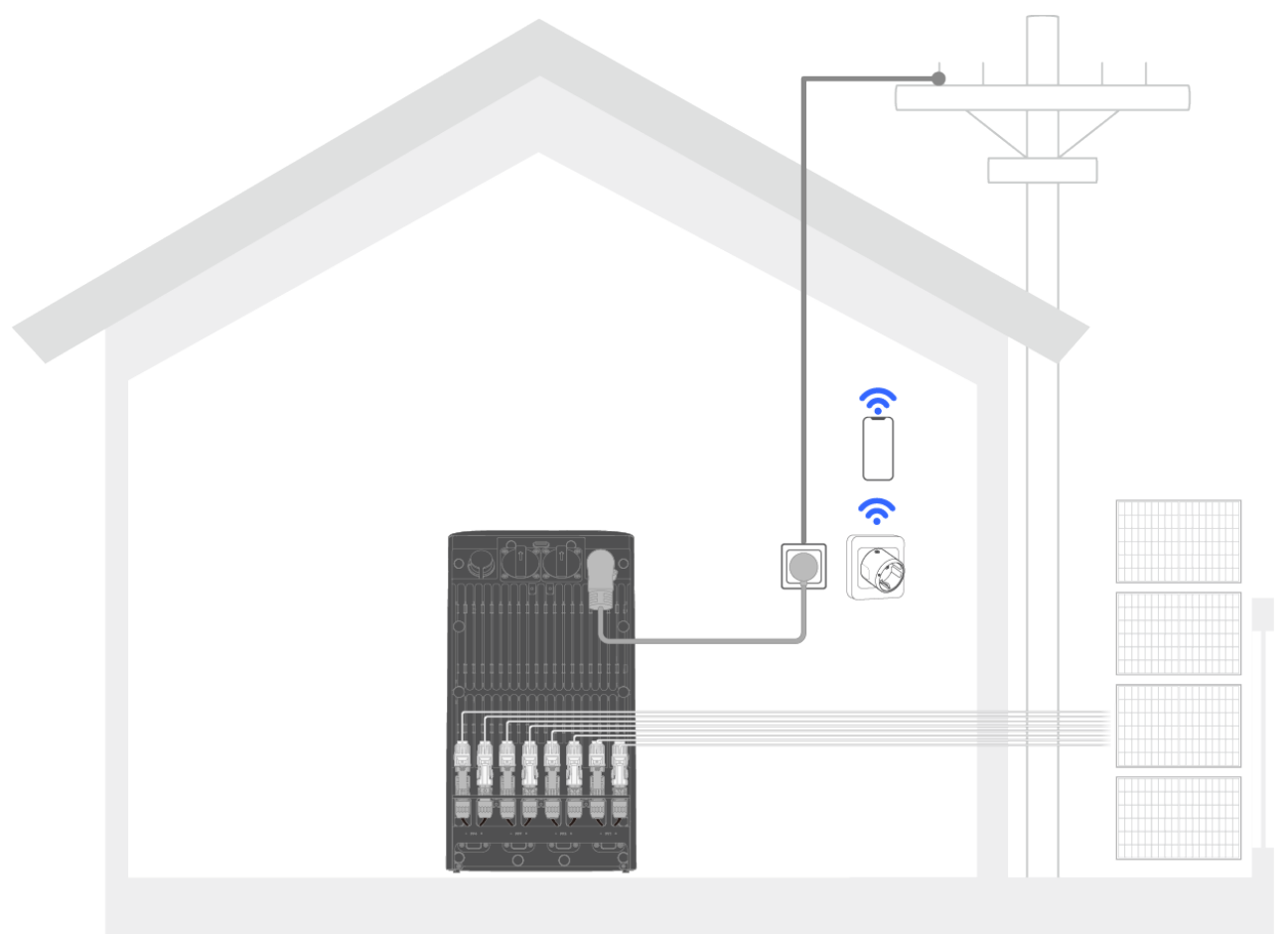

1. **Compatible Plug Model:**

- EcoFlow × Shelly Smart Plug (up to 6 units)
- EcoFlow Smart Plug (up to 16 units)

2. You can mix different plug models for up to 22 integrated plugs in a STREAM system.

3. Only one type of sensor can be added to the system at a time. Installing both the smart plug and smart meter may cause redundant data usage or sensor inefficiency, as the system can only operate in one scheduling mode.

Whole-Home Scheduling with Smart Meter

A smart meter functions as a household sensor that measures the difference between power drawn from the grid and power fed into it. The STREAM system uses this data to adjust feed-in power based on the overall household load,

ensuring efficient and balanced energy distribution across all connected STREAM devices.

- **To Install a Smart Meter**

Have a qualified electrician install the smart meter in your home's distribution box. Ensure it is connected to the same Wi-Fi network and bound to the same EcoFlow account as the STREAM system.

- **To Remove a Smart Meter**

1. Contact a qualified electrician to remove the smart meter.
2. Open the EcoFlow app and unbind the smart meter from the STREAM system if needed.

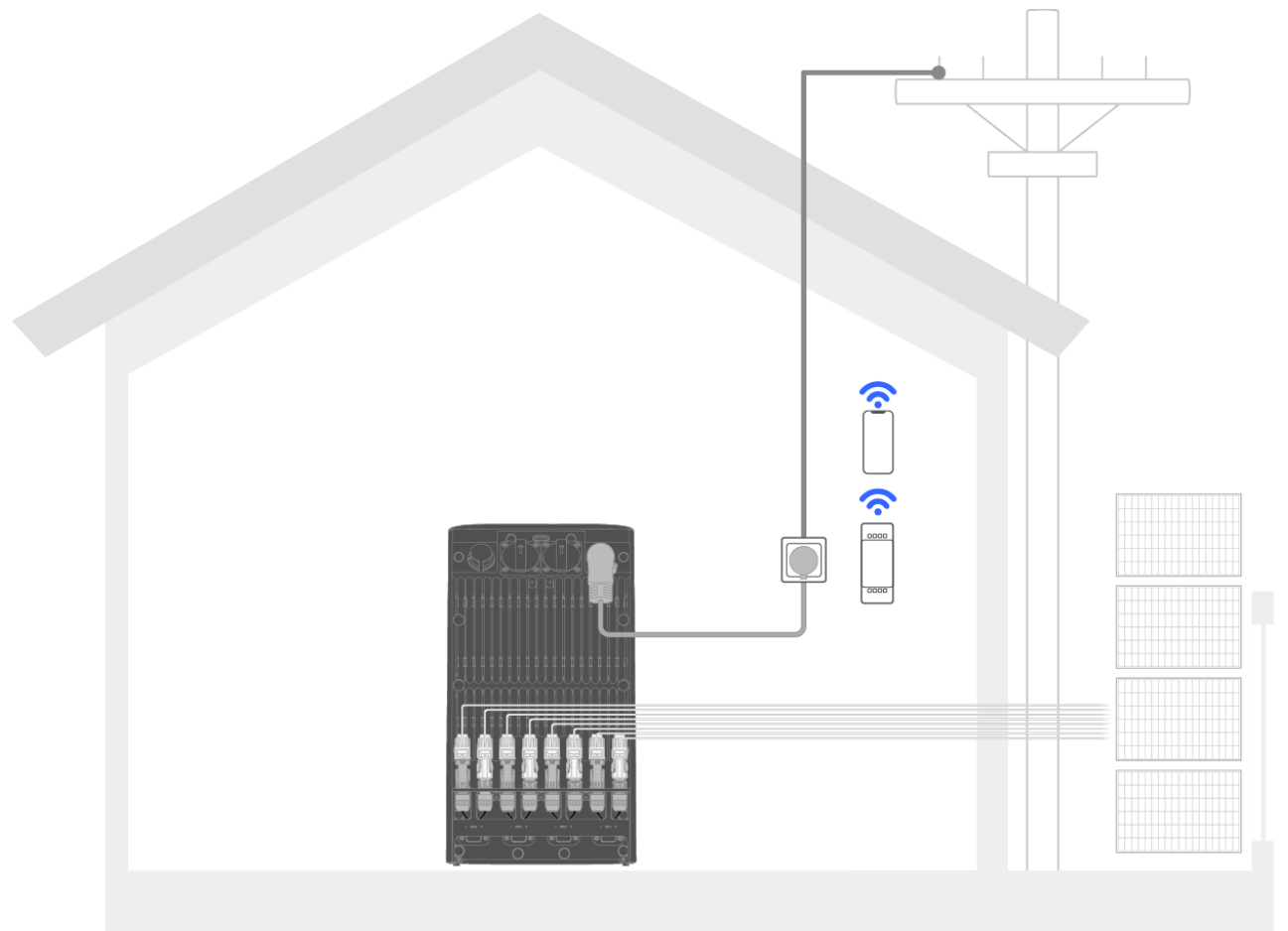

1. **Compatible Meter Model:**

- EcoFlow × Shelly Smart Meter
- EcoFlow Smart Meter
- Shelly 3em
- Shelly Pro 3em
- Tibber Pulse IR

2. Only 1 smart meter is needed for a STREAM system.

3. Only 1 sensor should be added to the system at a time. Installing both the smart plug and smart meter may cause redundant data usage or sensor inefficiency, as the system can only operate in one scheduling mode.

Storage and Maintenance

Routine Maintenance

For routine maintenance, follow these steps:

1. Use a soft, dry cloth to wipe the product shell and keep it clean.
2. Check if all the connection components are in good condition every 6 months.
3. If the device is not used for an extended period, charge and discharge the product every 3 months (fully charge it, then discharge it to 60% for storage) to maintain battery health. AC charging from the grid is the most recommended option in this case:
 - a. In the EcoFlow app, set the backup reserve level to 100% and fully charge the device.
 - b. After charging, set the reserve level to 60% to begin discharging for storage.



CAUTION! This product contains battery modules. The following precautions must be observed when working on batteries.

- Servicing of batteries should be performed or supervised by personnel knowledgeable about batteries and the required precautions.
- Do not dispose of batteries in a fire. The batteries may explode.
- Do not open or damage batteries. Released electrolytes are harmful to the skin and eyes. It may be toxic.
- A battery can present a risk of electrical shock and high short-circuit current. The following precautions should be observed when working on batteries:
 1. Remove watches, rings, or other metal objects.
 2. Use tools with insulated handles.
 3. Wear protective glasses, gloves, and boots.
 4. Do not lay tools or metal parts on top of batteries.
 5. Disconnect the charging source prior to connecting or disconnecting battery terminals.
 6. Determine if the battery is inadvertently grounded. If inadvertently grounded, remove source from ground. Contact with any part of a grounded battery can result in electric shock. The likelihood of such shock can be reduced if such grounds are removed during installation and maintenance (applicable to equipment and remote battery supplies not having a grounded supply circuit).

User-Replaceable Parts Maintenance

Product Removal

Before attempting any repairs, follow these steps to remove the device:

1. **Disable the AC Outlets:** Press the AC ON/OFF button once to turn off the outlets. Then disconnect the appliance and microinverter.
2. **Disconnect from Grid:** Unscrew the plug and tighten it on the device's grid terminal. Rotate the locking ring on the plug counterclockwise to unplug the cable.
3. **Disconnect the Paralleled STREAM Device (if applicable):** Unscrew the plug tightened on the device's parallel terminal. Rotate the locking ring on the plug counterclockwise to unplug the cable. Repeat this step if you have

paralleled multiple units.

4. **Disconnect from Solar:** Use the solar wrench provided in the product package to disconnect the solar cables from the PV terminal.
5. **Disconnect from Grid:** Unscrew the plug and tighten it on the device's grid terminal. Rotate the locking ring on the plug counterclockwise to unplug the cable.
6. **Detach the device (if applicable):** Unscrew the device from the mounting and locking brackets.
7. **Disposal (Optional) :** If the device can not work anymore, dispose of it in accordance with the local disposal requirements for electrical equipment waste.

DIY Front Case Replacement

Tool Requirements

1. Slotted screwdriver (e.g., SL3) or other suitable tool
2. Protective gloves (optional)

Steps

1. Disconnect all cables and remove the securing brackets(if applicable). Press and hold the power button for 2 seconds to power off it, then place it upside down vertically.
2. Use a screwdriver to pry the clips outward to loosen them, then remove the front case.

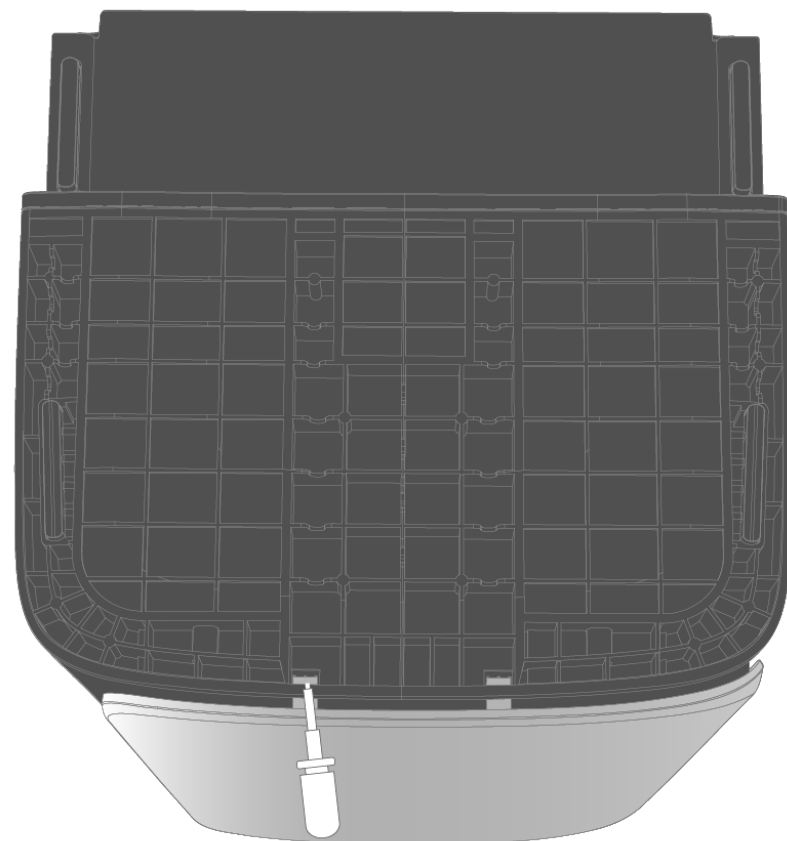

3. Pull the front case downward to disengage it from the slots, then remove the old front case.

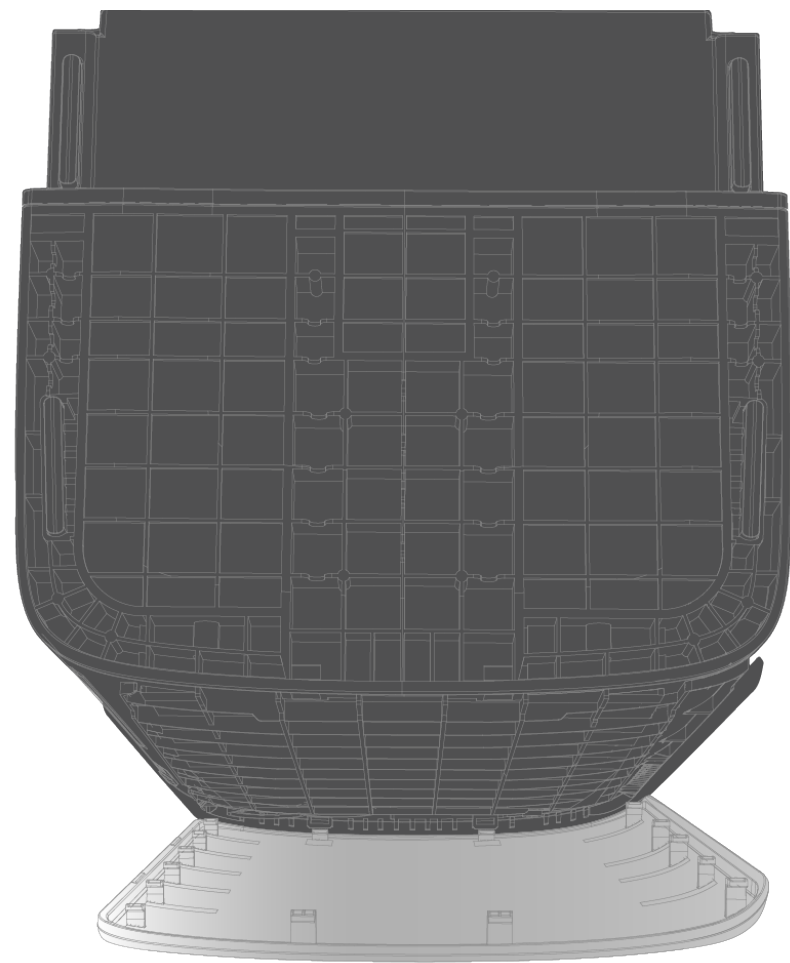

4. Adjust the device's position so that the front cover side faces upward. Slide the new front cover into the slots starting from the side near the IoT module, aligning it with the 4 slots to secure it in place. The installation of the new front cover is then complete.

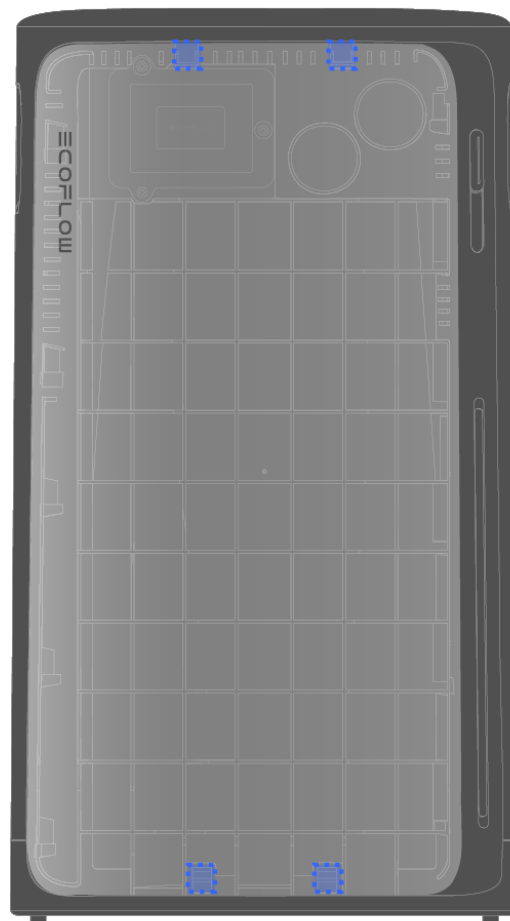

IoT Module Replacement

Prerequisites

Always contact the EcoFlow technical support team before attempting to replace the IoT module. Perform the following steps only after receiving the replacement module from EcoFlow.

Tool Requirements

1. Slotted screwdriver (e.g., SL3) or other suitable tool
2. PH1 screwdriver
3. Anti-static gloves

Steps

1. Disconnect all cables and remove the securing brackets(if applicable). Press and hold the power button for 2 seconds to power off it, then place it upside down vertically.
2. Use a screwdriver to pry the clips outward to loosen them, then remove the front case.
3. Locate the IoT module and use a PH1 screwdriver to remove its mounting screws (screw specification: M3)

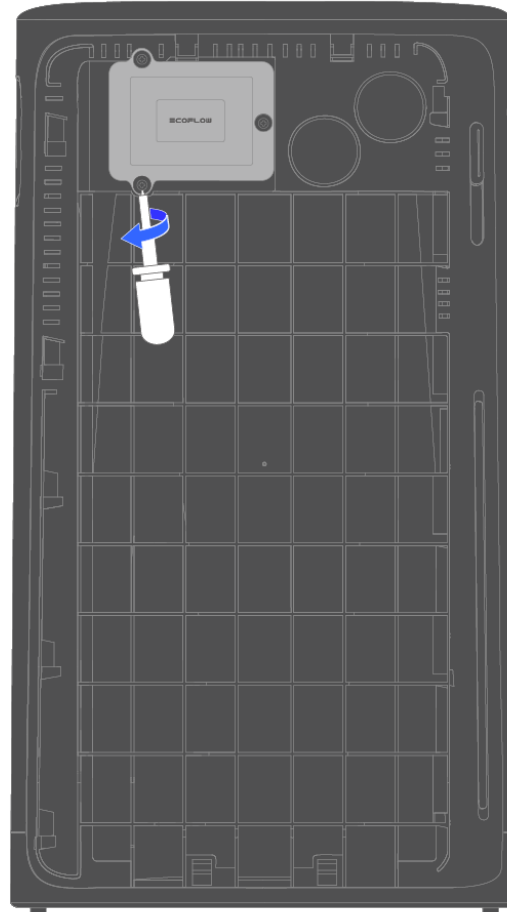

4. Carefully lift the PCB to expose the power cable underneath. Press the white latch and pull out the cable.

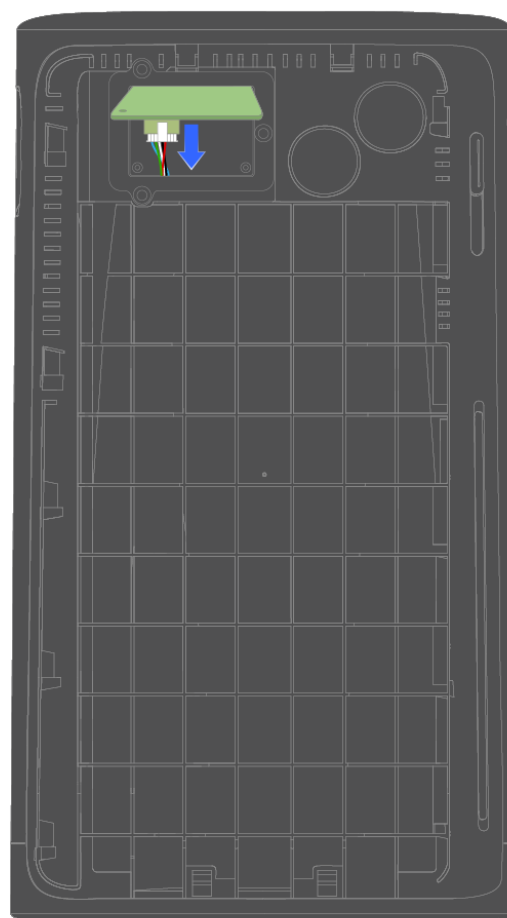

5. Pull out the signal cable directly from the PCB to fully remove the old IoT module.

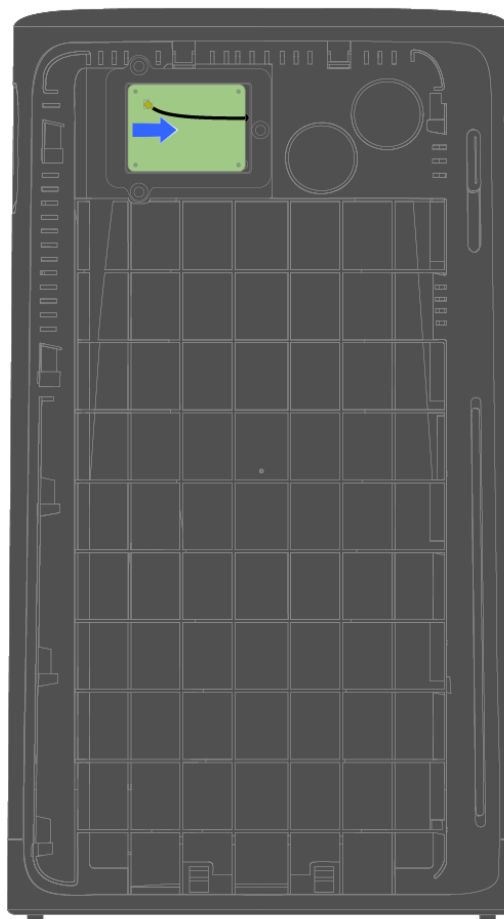

6. Connect the power and signal cables to the new IoT module, and place them in the correct position (avoid pinching the cables).
7. Reinstall the IoT protective cover and tighten the screws.
8. Reinstall the front case of the device.

Long-term Storage

For long-term storage, restore the device to its original package in a dry and tidy place. Protect all components to prevent severe moisture, shocks, vibrations, and so on. The product should be stored at temperatures between -40°C and $+85^{\circ}\text{C}$, with 25°C being the optimal storage temperature.

Troubleshooting

The device's LED provides a basic indicator to check the operating status. If you notice an abnormal LED pattern, refer to the in-app instructions for troubleshooting.

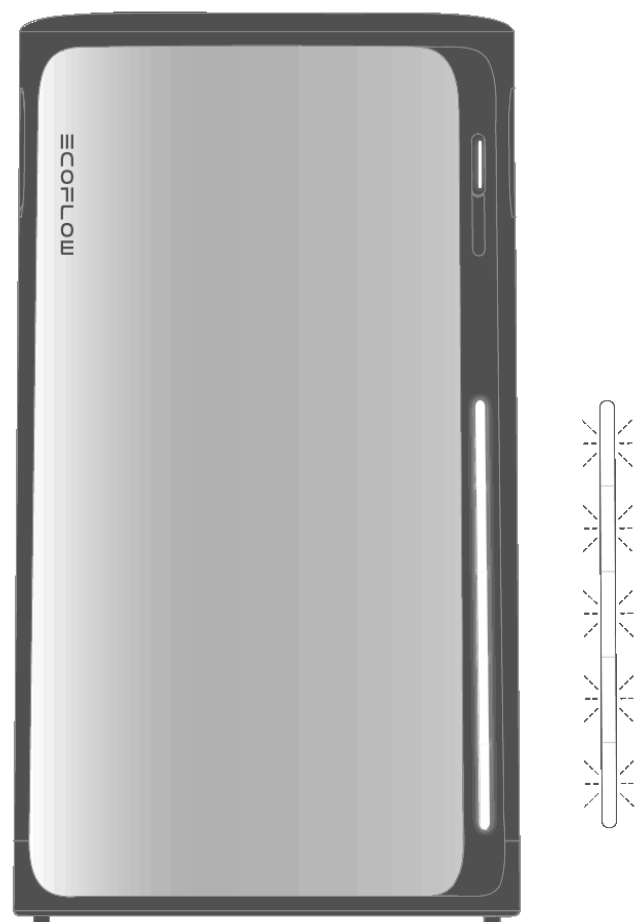

i If you cannot access the EcoFlow app, contact EcoFlow Customer Service for assistance. Do not attempt to repair this product without official instructions from the support team.

Safety Instructions and Regulatory Compliance

Disclaimer

Please read the product documentation thoroughly and ensure you understand it before using the product. Improper use may cause serious injury, product damage, or property loss. Always refer to the most up-to-date documentation available at <https://www.ecoflow.com/support/download/>. This documentation takes precedence over all other versions.

By using this product, you acknowledge and agree to all terms and conditions stated in the documentation. EcoFlow is not liable for losses caused by improper use or failure to adhere to the provided instructions. Subject to applicable laws and regulations, EcoFlow reserves the right to the final interpretation of this document and all documents related to the product.

Safety Symbols

The shell or nameplate of this product includes safety symbols to indicate potential hazards. Please review these signs and their meanings as detailed in the table below:

Note: "This product" or "the device" refers to the **EcoFlow STREAM Pro** or **EcoFlow STREAM Ultra** throughout this document.

**Caution**

Disconnect the device from all voltage sources before servicing.

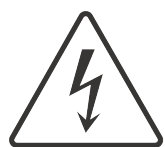
**Caution! Risk of Electric Shock**

Do not attempt to disassemble. No user-serviceable parts inside. Refer servicing to qualified personnel.

**Caution! Hot Surface**

Do not touch the enclosure of the device during operation.

**Caution! Risk of Electric Shock**

Wait at least 5 minutes after all voltage sources are disconnected before servicing.

**Reading Manual**

Read the user manual and all safety instructions carefully before installation, operation, and maintenance.

**CE Marking**

The device complies with the essential requirements of the relevant EU legislation.

**WEEE Directive**

Do not dispose of the device as household waste. Follow local electronic waste disposal regulations.

**Grounding**

Indicates the position for connecting the protective earthing (PE) cable.

Safety Instructions

1. Read this document and other related product documentation before any operation.
2. This product must be used in strict accordance with local electrical safety regulations and the applicable operating environment. Any damage resulting from causes unrelated to product quality or from improper use—including, but not limited to, short circuits caused by electrical equipment or the usage environment—is excluded from the scope of warranty coverage.
3. An overcurrent circuit breaker/fuse must be installed between this product and the grid.
4. When the photovoltaic (PV) array is exposed to light, it supplies direct current voltage to the power conversion equipment (PCE).
5. Use insulation tools and wear personal protective equipment when installing, servicing, or maintaining this product.
6. Install this product in a tidy, dry, and well-ventilated environment.
7. Keep the product out of reach of children and pets. If the product is to be used near children, they should be closely supervised.
8. We recommend not using cables longer than 3 meters.
9. Before making any electrical connections, ensure that any load to be

connected (e.g., devices or equipment intended to be powered by this product) is powered off.

10. Always pull the plug instead of the cord when disconnecting the product to reduce the risk of damage to the electric plug and cord.
11. Do not put fingers or hands into the product.
12. Do not expose this product to direct sunlight, rain, and snow.
13. Do not expose this product to strong electromagnetic fields to avoid radio interference.
14. Do not install or operate this product near flammable, explosive, corrosive, or caustic sources.
15. Do not install or operate this product during extreme weather events such as lightning, heavy rain, or strong wind.
16. Do not subject this product to severe impacts, vibrations, or drops to prevent physical damage.
17. Do not drag, squeeze, step on this product, or throw it into the fire, as there is a risk of explosion.
18. Do not use any damaged cords or cables with this product.
19. Do not damage, deface, or remove any labels on this product.
20. Do not disassemble, repair, or modify this product by yourself. For any maintenance or service, contact EcoFlow Customer Service.
21. Do not use any unofficial or unrecommended components and accessories. For any replacements, please contact EcoFlow for further assistance.
22. Do not clean the product with flammable or toxic solvents. Wipe it with a dry soft cloth.
23. Do not place heavy objects (> 40 kg) on the product.
24. **Device Removal:** To safely remove this product, perform the following steps in sequence:
 - a. Power off the connected load.
 - b. Disconnect the cables from the **AC outlets**.
 - c. Disconnect the cable from the **Grid terminal**.
 - d. Disconnect the cables from the **PV terminals**.
 - e. Power off the product.
25. **GROUNDING INSTRUCTIONS:** This product must be grounded. If it should malfunction or breakdown, grounding provides a path of least resistance for electric current to reduce the risk of electric shock. For your safety, EcoFlow provides a cord with an equipment grounding conductor/a grounding plug. The plug must be plugged into an outlet that is properly installed and grounded in accordance with all local codes and ordinances. **WARNING** – Improper connection of the equipment grounding conductor can result in a risk of electric shock. If you encounter the following situations, consult a qualified electrician instead of modifying the plug provided with the product:
 - You are unsure whether the product is properly grounded;
 - You find that the plug provided with the product does not fit the outlet.
26. **Personnel Requirement:** Certain installation or servicing tasks must be performed exclusively by a qualified technician. Refer to the personnel requirements highlighted in the product documentation to ensure these tasks are completed correctly and safely.
27. **Floating Ground Notice:** The **grounding terminal is not connected to the AC neutral line**. The internal electrical system remains isolated from the earth when the device (and its cascading system, if applicable) is disconnected from grid power.
28. **External Grounding Instructions:** Supplemental grounding may be necessary at installation sites with inadequate grounding or specific

grounding requirements mandated by local codes. In such cases, the grounding terminal of this product should be used to establish proper grounding.

Regulatory Compliance



Hereby, EcoFlow Inc. declares that this product is in compliance with Directives 2014/35/EU, 2014/30/EU, 2014/53/EU, 2011/65/EU+(EU)2015/863, (EU) 2023/1542. The full text of the EU Declaration of Conformity is available at the following Internet address: <http://www.ecoflow.com/eu/eu-compliance>

Radio Frequency (RF) Specifications for EU:

- Bluetooth:
 - Frequency: 2402-2480 MHz
 - Maximum Output Power: <20 dBm
- WLAN :
 - Frequency: 2412-2472 MHz / 2422-2462 MHz
 - Maximum Output Power: <20 dBm



This marking indicates that this product should not be disposed of with other household waste within the EU. Recycle this product properly to prevent possible damage to the environment or a risk to human health via uncontrolled waste disposal and in order to promote the sustainable reuse of material resources. Please return your used product to an appropriate collection point or contact the retailer where you purchased this product. Your retailer will accept used products and return them to an environmentally-sound recycling facility.

For information on the disposal of electrical and electronic equipment, please visit the following website:

<https://eu.ecoflow.com/pages/electronic-devices-disposal>



The Bluetooth® word mark and logos are registered trademarks owned by Bluetooth SIG, Inc. and any use of such marks by EcoFlow Inc. is under license. Other trademarks and trade names are those of their respective owners.

Appendix

What's in the Box

- 1× EcoFlow STREAM Ultra / EcoFlow STREAM Pro
- n× EcoFlow STREAM Solar Panel Extension Cable (2.95m)[†]
- 1× EcoFlow STREAM AC Cable (1.5m) / 1× EcoFlow STREAM DIY Cable (1.5m)[‡]
- 1× PV wrench
- 1× Mounting bracket
- 1× Locking bracket
- 4× M4*8 Screws

- 2x Expansion screws with anchors

† The STREAM Ultra comes with 8 PV cables in the delivery, while the STREAM Pro comes with 6. This is determined by the number of PV terminals on each device.

‡ The actual appearance of the AC cable may vary by sales region and product version.



If any item is damaged or missing, contact EcoFlow Customer Service for assistance.

Technical Specification

EcoFlow STREAM Ultra

General Info	
Model	EF-EA-HD-U2K-800, EF-EA-HD-U2K-600, EF-EA-HD-U2K-1200, EF-EA-HD-U2K-790
Dimensions	255 × 284 × 458 mm
Net. Weight	23.1 kg
Typology	Isolated
IP Rating	IP65
Pollution Degree	PD3
OVC Category	DC: II, AC: III
Environmental Category	Outdoor / Indoor
Cooling Method	Natural convection (no fans)
Battery Info	
Rated Capacity	1.92kWh

Rated Voltage	19.2V \approx
Cycle Life ¹	6000
Cell Chemistry LFP	LFP (LiFePO ₄)
PV Terminal (DC)	
Number of MPPTs	4
Range of MPPT Voltage	15V-60V \approx
Max. Input Power	2000W (500W per MPPT)
Max. Input Voltage	60V \approx
Max. Input Current	14A
Max. Input Short Circuit Current	20A
Grid Terminal (AC)	
Rated Voltage and Frequency	230V~, 50Hz
Rated Output Power	EF-EA-HD-U2K-800: 800W EF-EA-HD-U2K-600: 600W
Rated Output Current	EF-EA-HD-U2K-800: 3.48A EF-EA-HD-U2K-600: 2.61A
Max. Input Current	10A
Max. Input Power	2300W
Power Factor	1(-0.8 to +0.8)
AC Outlet (AC)	
Rated Voltage and Frequency	230V~, 50Hz
Max. Output Power	1200W
Max. Output Apparent Power	1200VA
Rated Output Current	5.22A
Max. Output Current (Bypass Mode)	10A
Max. Input Power	EF-EA-HD-U2K-800: 800W EF-EA-HD-U2K-600: 600W
Max. Input Apparent Power	EF-EA-HD-U2K-800: 800VA EF-EA-HD-U2K-600: 600VA
Max. Input Current	EF-EA-HD-U2K-800: 3.48A EF-EA-HD-U2K-600: 2.61A

Power Factor	1(-0.8 to +0.8)
--------------	-----------------

Parallel Terminal (AC)

Rated Voltage and Frequency	230V~, 50Hz
-----------------------------	-------------

Max. Output Power	2300W
-------------------	-------

Max. Output Apparent Power	2300VA
----------------------------	--------

Max. Output Current	10A
---------------------	-----

Max. Input Current	10A
--------------------	-----

Max. Input Power	2300W
------------------	-------

Max. Input Apparent Power	2300VA
---------------------------	--------

Power Factor	1(-0.8 to +0.8)
--------------	-----------------

Environment

Operating Altitude	≤ 4000 m
--------------------	----------

Operating Temperature ²	-20°C to 55°C
------------------------------------	---------------

Storage Temperature	-20°C to 55°C
---------------------	---------------

Relative Humidity	5%-95%
-------------------	--------

Features

Communication	WLAN, Bluetooth
---------------	-----------------

Management	EcoFlow app
------------	-------------

¹ Test conditions: 0.5C/0.5C charge/discharge at 25°C (77°F).
² The performance may be derated at temperatures above 35°C.

EcoFlow STREAM Pro

General Info

Model	EF-EA-HD-P2K-800, EF-EA-HD-P2K-600, EF-EA-HD-P2K-1200, EF-EA-HD-P2K-790
-------	---

Dimensions	255× 284 × 458 mm
------------	-------------------

Net. Weight	22.8 kg
-------------	---------

Typology	Isolated
----------	----------

IP Rating	IP65
-----------	------

Pollution Degree	PD3
------------------	-----

OVC Category	DC: II, AC: III
Environmental Category	Outdoor / Indoor
Cooling Method	Natural convection (no fans)
Battery Info	
Rated Capacity	1.92kWh
Rated Voltage	19.2V \equiv
Cycle Life ¹	6000
Cell Chemistry	LFP (LiFePO ₄)
PV Terminal (DC)	
Number of MPPTs	3
Range of MPPT Voltage	15V-60V \equiv
Max. Input Power	1500W (500W per MPPT)
Max. Input Voltage	60V \equiv
Max. Input Current	14A
Max. Input Short Circuit Current	20A
Grid Terminal (AC)	
Rated Voltage and Frequency	230V~, 50Hz
Rated Output Power	EF-EA-HD-P2K-800: 800W EF-EA-HD-P2K-600: 600W
Rated Output Current	EF-EA-HD-P2K-800: 3.48A EF-EA-HD-P2K-600: 2.61A
Max. Input Current	10A
Max. Input Power	2300W
Power Factor	1(-0.8 to +0.8)
AC Outlet (AC)	
Rated Voltage and Frequency	230V~, 50Hz
Max. Output Power	1200W
Max. Output Apparent Power	1200VA
Max. Output Current	5.22A
Max. Output Current (Bypass Mode)	10A

Max. Input Power	EF-EA-HD-P2K-800: 800W EF-EA-HD-P2K-600: 600W
Max. Input Apparent Power	EF-EA-HD-P2K-800: 800VA EF-EA-HD-P2K-600: 600VA
Max. Input Current	EF-EA-HD-P2K-800: 3.48A EF-EA-HD-P2K-600: 2.61A
Power Factor	1(-0.8 to +0.8)

Parallel Terminal (AC)

Rated Voltage and Frequency	230V~, 50Hz
Max. Output Power	2300W
Max. Output Apparent Power	2300VA
Max. Output Current	10A
Max. Input Current	10A
Max. Input Power	2300W
Max. Input Apparent Power	2300VA
Power Factor	1(-0.8 to +0.8)

Environment

Operating Altitude	≤ 4000 m
Operating Temperature ²	-20°C to 55°C
Storage Temperature	-20°C to 55°C
Relative Humidity	5%-95%

Features

Communication	WLAN, Bluetooth
Management	EcoFlow app

¹ Test conditions: 0.5C/0.5C charge/discharge at 25°C (77°F).

² The performance may be derated at temperatures above 35°C.

Product Compatibility List

Solar Panel	Brand	Specification / Model
	EcoFlow	Solar panels that meet the following requirements:

- or third-party
- 1. MPPT Voltage Range: 16–60V
- 2. Maximum MPPT Current: 14A

Microinverter	Brand	Specification / Model
	EcoFlow	<ul style="list-style-type: none"> • EcoFlow PowerStream Microinverter • EcoFlow STREAM Microinverter
	Third-party	<ul style="list-style-type: none"> • (100% compatible)
Smart Plug	Brand	Specification / Model
<i>*Support STREAM System Scheduling</i>	EcoFlow	<ul style="list-style-type: none"> • EcoFlow Smart Plug
<i>*Support STREAM System Scheduling</i>	EcoFlow x Shelly	<ul style="list-style-type: none"> • EcoFlow x Shelly Smart Plug - Shelly Plug S MTR Gen3 - Shelly Plus Plug UK
<i>*Support Customized Automation via the EcoFlow App (coming in June 2025)</i>	Shelly	<ul style="list-style-type: none"> • Shelly Plug S • Shelly Plus Plug S • Shelly Plus Plug US (1-channel) • Shelly Plus Plug UK (1-channel) • Shelly Plus Plug IT (1-channel) • Shelly Plus 1 • Shelly Plus 1PM UL (1-channel) • Shelly Plus 2PM (2-channel) • Shelly Pro 1 (1-channel) • Shelly Pro 1PM (1-channel) • Shelly Pro 2 (2-channel) • Shelly Pro 2PM (2-channel) • Shelly Pro 3 (3-channel) • Shelly Pro 4PM (4-channel)
<i>*Support Customized Automation via the EcoFlow App (coming in June 2025)</i>	Kasa	<ul style="list-style-type: none"> • EP10
<i>*Support Customized Automation via the EcoFlow App (coming in June 2025)</i>	Tapo	<ul style="list-style-type: none"> • P100 • P115 • P125M
Smart Meter	Brand	Specification / Model
	EcoFlow	<ul style="list-style-type: none"> • EcoFlow Smart Meter
	EcoFlow x Shelly	<ul style="list-style-type: none"> • EcoFlow x Shelly Smart Meter Shelly pro 3em (SPEM-003CEBEU120, SPEM-003CEBEU)
	Shelly	<ul style="list-style-type: none"> • Shelly 3em • Shelly PRO 3EM (SPEM-003CEBEU120, SPEM-003CEBEU)
	Tibber	<ul style="list-style-type: none"> • Tibber Pulse IR

Heater	Brand	Specification / Model
--------	-------	-----------------------

EcoFlow • EcoFlow POWERHEAT 3.5kW

Power Station	Brand	Specification / Model
---------------	-------	-----------------------

**Support Customized Automation via the EcoFlow App (coming soon)*

- EcoFlow
- DELTA 2
 - DELTA 2 Max
 - DELTA 3
 - DELTA 3 Max
 - DELTA 3 Plus
 - DELTA 2 (1.5 kWh)

PowerMarket & Dynamic Tariff Integration	Brand	Specification / Model
--	-------	-----------------------

1. Nordpool
 2. EPEX Spot
 3. Rabot charge
 4. Octopus
 5. Tibber
1. Nordpool
 2. EPEX Spot
 3. Rabot charge
 4. Octopus
 5. Tibber Wholesale

Thermostat	Brand	Specification / Model
------------	-------	-----------------------

Google Nest • Google Nest Thermostat

Tado

Compatible with Tado devices released before 2024, including but not limited to:

- Smarte Klimaanlagesteuerung V3
- Smartes Heizkörperthermostat
- Funk-Temperatursensor X

EcoBee • EcoBee Thermostat aresSmart



The compatibility list reflects supported models at the time of publication. More ecosystem brands and models will be supported soon. For the latest updates, visit the official product website: <https://www.ecoflow.com>.